SOLAR PHOTOVOLTAIC AND THERMAL SYSTEMS ACCEPTANCE REQUIREMENTS

IR 16-8

References: 2007 California Building Code (CBC), Sections 1609A and 1613A
2007 California Electrical Code (CEC), Articles 250, 310, and 609
California State Fire Marshal Photovoltaic Installation Guideline dated April 22, 2008

Issued 08-15-08

Discipline: Structural, Access Compliance, Fire-Life Safety, Electrical

This Interpretation of Regulations (IR) is intended for use by the Division of the State Architect (DSA) staff, and as a resource for design professionals, to promote more uniform statewide criteria for plan review and construction inspection of projects within the jurisdiction of DSA, which include State of California public elementary and secondary schools (grades K-12), community colleges, and state-owned or state-leased essential services buildings. This IR indicates an acceptable method for achieving compliance with applicable codes and regulations, although other methods proposed by design professionals may be considered by DSA.

This IR is reviewed on a regular basis and is subject to revision at any time. Please check the DSA web site for currently effective IR's. Only IR's listed in the document at <http://www.dsa.dgs.ca.gov/Pubs/default.htm> (click on "DSA Interpretation of Regulations Manual") at the time of plan submittal to DSA are considered applicable.

Purpose: This Interpretation of Regulations (IR) describes the Division of the State Architect (DSA) requirements for acceptance of solar photovoltaic and solar thermal systems used in construction projects under the jurisdiction of DSA

Scope: This IR clarifies the requirements for structural support, and anchorage of panels and balance-of-system (BOS) equipment. It also addresses the basic Fire-Life Safety and some Electrical requirements of the California Building Code (CBC).

Photovoltaic roofing systems (such as tiles) that incorporate photovoltaic technology physically integrated into the roof covering materials are outside the scope of this IR.

Background: Typical photovoltaic (PV) or solar thermal systems consist of solar panels and BOS equipment. The BOS equipment includes foundations, support structures, DC-to-AC inverters, electrical wiring, electrical protection, monitoring, and safety equipment.

Photovoltaic panels are anchored to building structures. The anchoring relies on various attachment systems such as support frames (Section 3, below), ballast (Section 4, below), or adhered systems (Section 5, below).

Solar thermal panels are typically anchored by support structures.

1. DESIGN AND CONSTRUCTION OF SOLAR ENERGY SYSTEMS: DSA will not review the design and construction of the panels and the BOS equipment. However, the panels and BOS equipment must be designed and constructed to meet the requirements of Title 24.

See Sections 7 and 8 below for the requirements of Access Compliance and Fire-Life Safety, respectively.

2. REVIEW OF SOLAR PHOTOVOLTAIC AND THERMAL SYSTEMS: The Division of the State Architect Structural Safety reviews the anchorage of solar panels and their BOS equipment to the building structure or foundation. The anchorage design for solar panels and their BOS equipment must meet the wind force requirements of the CBC, Section 1609A and the seismic requirements of ASCE 7-05, Chapter 13.

Manufacturer's support frames will also be review by DSA. The building's vertical and lateral load resisting systems will also be evaluated for the additional loads from the solar panels and BOS equipment.

2.1 Projects Exempt from DSA Review:

Additions of solar energy systems to existing buildings may be exempt from DSA review when the total cost of the project (including any other construction, site work, etc.) is less than the cost limit indicated in [IR A-10](#) for alteration projects. The cost limit is adjusted annually, from a baseline cost of \$25,000 in 1999 dollars as required by Title 24, Part 1, Sections 4-308 and 4-309. The adjusted cost limit is published in IR A-10 annually.

All solar energy systems and their installation, including projects exempt from DSA review, shall meet the requirements of Title 24 and applicable provisions of this IR.

- 2.1.1 Exception:** Regardless of costs, solar energy systems installed on or supported by free standing structures (whether standing alone or attached to existing buildings) are not exempted from DSA review. Examples of free standing structures are shade structures, lunch shelters, canopies, large arrays of panels supported on a single pole, etc.

3. PANELS SUPPORTED ON FRAMING SYSTEMS AND FOUNDATIONS:

DSA will review support frames either supplied by manufacturers or designed by the architects or structural engineers in general responsible charge (see Section 6 below), foundations, primary structure, the connection details of panels to support frames and connection details of support frames to primary structures or foundations. The design of the support frames, foundations and connections must meet the following wind and seismic requirements:

- 3.1 Requirements for Wind Design:** The wind design requirements are given in CBC Section 1609A. The design shall consider the effects of partially enclosed structure configuration (if presented), and discontinuities at panel free edges and corners.

- 3.2 Requirements for Seismic Design:** The seismic anchorage design requirements are given in CBC Section 1613A, and ASCE Standard 7-05, Chapter 13.

4. BALLAST PANEL SYSTEMS: Ballast panels may only be installed on a flat roof with minimal slope for drainage purposes. Panels in a ballast system are not attached to the roof. They rely on their weights and aerodynamics to counter the wind uplift forces.

- 4.1 Requirements for Wind Design:** The panels shall be designed and installed to resist wind loads prescribed in CBC, Section 1609A. The minimum design wind force shall be a net pressure of 10 lb/ft² acting in either direction normal to the panels per ASCE 7, Section 6.1.4.2.

Wind tunnel test reports for wind (uplift) are required to verify the design.

- 4.2 Requirements for Seismic Design:** The panels must be seismically restrained from falling off the roof or excessive movements on the roof. Individual panels need not be restrained independently if the panels are connected with an interlocking mechanism that is capable of holding the panels together in the horizontal and vertical directions.

The overall panel array must be restrained. The restraint and panel interlocking mechanism must be designed to resist sliding and pop-up resulting from lateral and vertical seismic forces and displacements per CBC Section 1613A, and ASCE Standard 7-05, Chapter 13. The restraint and panel interlocking mechanism may be verified either through time-history non-linear dynamic analysis or shake table testing in accordance with International Code Council (ICC) Evaluation Service (ES) Acceptance Criteria AC-156.

- 4.2.1 Flexible utility connections, such as electrical cables, may be required to accommodate movement of the panels.
- 4.2.2 BOS equipment shall be anchored per CBC Section 1613A, and ASCE Standard 7-05, Chapter 13.
- 4.3 **Other Considerations:** Ballast panel systems shall not cause excessive sagging of the roof resulting in ponding. They shall also not block or impede drainage flows to any overflow drains and scuppers.

5. ADHERED PHOTOVOLTAIC PANELS: Adhered photovoltaic panels are attached to supports by adhesive. Currently, there are no building code criteria, ASTM standards, ICC evaluation criteria, or other recognized industrial standard for adhesives used to anchor solar panels. Adhered photovoltaic panels may be accepted if test and analysis data, and quality control and assurance program are submitted that demonstrate an equivalent level of safety as positive mechanical anchorage systems.

The local DSA Regional Office should be contacted early in the design phase if an adhered system is anticipated.

6. SUBMITTAL REQUIREMENTS: All projects involving installation of photovoltaic or solar thermal systems shall have a California licensed or registered architect or structural engineer in general responsible charge per Title 24, Part 1, Section 4-316. Applications for project review shall be submitted to the DSA Regional Offices, following the normal process for project submittal. An [overview](#) of the project submittal process and requirements may be found on the DSA web site. (See Appendix B for web links.)

In addition to the above requirements, the following items are also required for review:

6.1 General

- 6.1.1 Construction plans and specifications shall be signed and stamped by architect or structural engineer in general responsible charge per [IR A-19](#). The architect or structural engineer in general responsible may use construction plans and specifications prepared by the manufacturer's California registered engineer provided the requirements of [IR A-18](#) are met.
- 6.1.2 The plans and specifications shall including anchorage or restraint details of the panels, BOS equipment, support structures, and foundations. Also submit any applicable anchorage calculations.
- 6.1.3 Shop drawings or fabrication and installation drawings of the system.
- 6.1.4 Calculations to verify that the primary structure will support the additional vertical and lateral loads from the panels and BOS equipment. Also provide calculations verifying that roof deflection will not cause ponding.
- 6.1.5 **Roof Live Loads on Panels.** It is not necessary to include roof live load (20 psf) in the area(s) covered by the panels when these area(s) are inaccessible, or fenced off with posted signs prohibiting storage under the panels.

When applicable, include snow loads and loads from snow drift.

6.2 Ballast Panel Systems

- 6.2.1 Wind tunnel test reports that address wind uplift per Section 4.1.2 above. Listings or evaluation reports issued by ICC Evaluation Services, Dade County, or other recognized testing and evaluation organizations per [IR A-5](#) may be substituted for wind tunnel test reports if the listings or evaluation reports were issued on the basis of wind tunnel testing.

6.2.2 Provide Panel Interlocking system verification using either a time-history non-linear dynamic analysis or shake table testing in accordance with ICC ES Acceptance Criteria AC-15-6, per Section 4.2 above.

7. ACCESS COMPLIANCE: Projects which consist only of solar energy system work installed on existing buildings do not trigger accessibility code requirements or DSA accessibility review. See Section 1134B.2.1, Exception 4, Part 2, Title 24, CCR, for detailed requirements. Also see DSA [IR 11B-6](#), Mechanical Only Projects Exempt from Accessibility Review.

8. FIRE-LIFE SAFETY: The installation of solar or thermal systems will be reviewed for code compliance by adherence to the [State Fire Marshal Solar Photovoltaic Installation Guideline](#) in all respects including any additional amendments, supplements, or official interpretations. Other proposed means of achieving compliance will be considered and evaluated.

8.1 Fire-Life Safety Review: Photovoltaic and thermal stand alone systems that have support structures of combustible materials shall be located per CBC requirements and may not be located in Frontage areas used for adjacent building area increases. Noncombustible support structures and BOS equipment may be located next to adjacent buildings provided exiting is maintained and are not required to have automatic fire sprinkler system coverage where the configuration of the system will not allow heat, smoke or gasses to be trapped. Noncombustible stand alone systems need not be included in the basic area calculations.

8.2 Requirements for Fire-Life Safety Design: When panels are supported on framing systems and foundations, they shall be of non-combustible materials and shall be designed so that heat, smoke and other gasses can not be trapped under the panels. Framing systems may not be placed in designated fire access lanes. Combustible framing systems may not be placed within the 2007 CBC "Frontage Increase" areas of buildings constructed under the 2007 CBC, nor within the required side yard areas for existing buildings constructed under previous codes, without prior approval of DSA Fire-Life Safety.

9. ELECTRICAL REQUIREMENTS: Solar energy systems shall meet the requirements of the 2007 California Electrical Code (CEC). All systems shall be grounded in accordance with the 2007 CEC, Article 250. Electrical cables and materials shall meet the criteria for weather proof locations per the 2007 CEC, Article 310. Solar photovoltaic systems shall comply with the requirements of 2007 CEC, Article 690. Appendix A shows an example of a PV system grounding.

Appendices:

Appendix A – Example of PV System Grounding

Appendix B – Hyperlinks to Web Pages

Appendix A: Example of PV System Grounding

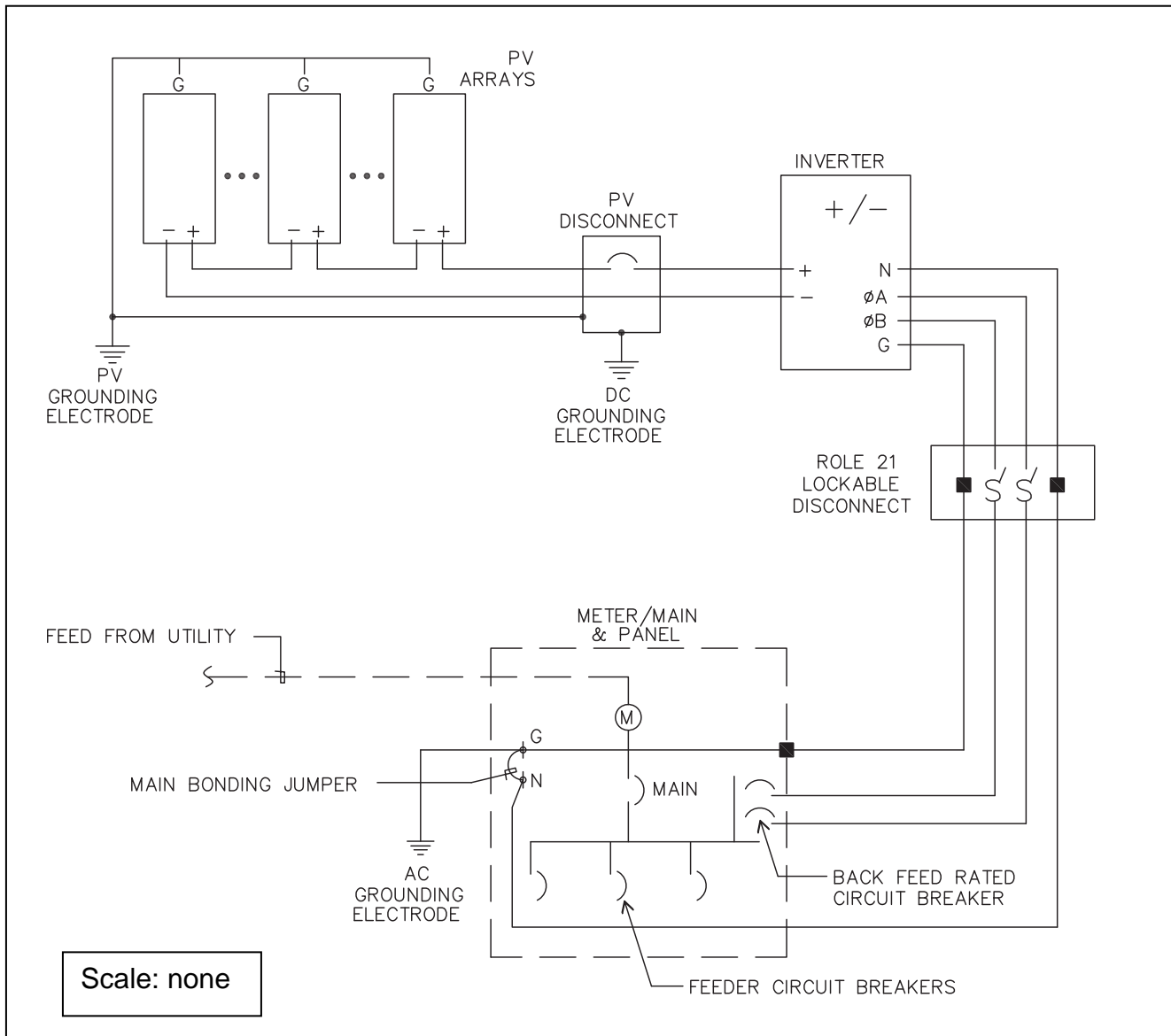

Appendix B: Hyperlinks to Web Pages

Some of the documents referenced in this IR are available from the following web pages:

IR A-5: http://www.documents.dgs.ca.gov/dsa/pubs/IR_A-5_rev06-02-08.pdf

IR A-10: http://www.documents.dgs.ca.gov/dsa/pubs/IR_A-10_03-17-08.pdf

IR A-18: http://www.documents.dgs.ca.gov/dsa/pubs/IR_A-18_issued02-01-08.pdf

IR A-19: http://www.documents.dgs.ca.gov/dsa/pubs/IR_A-19_rev04-07-08.pdf

IR 11B-6: http://www.documents.dgs.ca.gov/dsa/pubs/IR_11B-6_02-04-08.pdf

Overview of DSA Submittal Process: <http://www.dsa.dgs.ca.gov/PlanRev/overview.htm>

Fire Marshall's Guidelines: <http://www.osfm.fire.ca.gov/pdf/reports/solarphotovoltaicguideline.pdf>

**CALIFORNIA DEPARTMENT of FORESTRY
and FIRE PROTECTION
OFFICE OF THE STATE FIRE MARSHAL**



**SOLAR PHOTOVOLTAIC
INSTALLATION GUIDELINE**

**(In partnership with interested local fire officials, building officials,
and industry representatives)**

April 22, 2008

SOLAR PHOTOVOLTAIC INSTALLATION GUIDELINE

April 22, 2008

TABLE OF CONTENTS

ABOUT THE GUIDELINE	3
GENERAL INFORMATION ABOUT SOLAR PHOTOVOLTAIC SYSTEMS.....	3
RESOURCES	5
TASK FORCE PARTICIPANTS	5
ADOPTING THE GUIDELINE	6
GENERAL	6
LOCAL ORDINANCE REQUIRED BY CITY, COUNTY, CITY AND COUNTY, FIRE PROTECTION DISTRICTS	6
FINDINGS AND FILINGS	7
WORDING	7
1.0 MARKING.....	7
1.1 MAIN SERVICE DISCONNECT.....	7
1.1.1 MARKING CONTENT AND FORMAT.....	8
1.2 MARKING FOR DIRECT CURRENT (DC) CONDUIT, RACEWAYS, ENCLOSURES, CABLE ASSEMBLIES, AND JUNCTION BOXES	8
1.2.1 MARKING CONTENT AND FORMAT.....	8
1.3 INVERTERS	9
2.0 ACCESS, PATHWAYS AND SMOKE VENTILATION.....	9
2.1 RESIDENTIAL SYSTEMS—SINGLE AND TWO-UNIT RESIDENTIAL DWELLINGS	9
2.1.1 ACCESS/PATHWAY	10
2.1.2 SMOKE VENTILATION	10
2.2 COMMERCIAL BUILDINGS AND RESIDENTIAL HOUSING COMPRISED OF THREE (3) OR MORE UNITS.....	10
2.2.1 ACCESS.....	10
2.2.2 PATHWAYS	11
2.2.3 SMOKE VENTILATION	11
3.0 LOCATION OF DIRECT CURRENT (DC) CONDUCTORS.....	11
4.0 NON-HABITABLE BUILDINGS	11
5.0 GROUND MOUNTED PHOTOVOLTAIC	12
EXAMPLE 1 – CROSS GABLE ROOF	13
EXAMPLE 2 – CROSS GABLE WITH VALLEY	13
EXAMPLE 3 – FULL GABLE.....	14
EXAMPLE 4 – FULL HIP ROOF	14
EXAMPLE 5 – LARGE COMMERCIAL 8’ WALKWAYS.....	15
EXAMPLE 6 – LARGE COMMERCIAL 4’ WALKWAYS.....	16
EXAMPLE 7 – SMALL COMMERCIAL 4’ WALKWAYS.....	17
EXAMPLE 8 – SMALL COMMERCIAL 8’ WALKWAYS.....	18

About the Guideline

The California Department of Forestry and Fire Protection - Office of the State Fire Marshal (CAL FIRE-OSFM), local Fire Departments (FD), and the solar photovoltaic industry have developed this guideline for installations to increase public safety for all structures equipped with solar photovoltaic systems.

This guideline was developed with safety as the principal objective. The solar photovoltaic industry has been presented with certain limitations in roof installations due to firefighting suppression techniques. The intent of this guideline is to provide the solar photovoltaic industry with information that will aid in the designing, building, and installation of solar photovoltaic systems in a manner that should meet the objectives of both the solar photovoltaic industry and the Fire Service.

The provisions of this guideline, if adopted by the local enforcing agency by local ordinance, is meant to apply to the design, construction and installation of solar photovoltaic systems on buildings regulated by Title 24 of the California Building Standards Codes.

A solar contractor should always contact their local fire department to determine if the means or methods to be used will allow for a safe installation that is acceptable to the fire department and meets local code requirements.

General Information about Solar Photovoltaic Systems

Solar photovoltaic systems generate electricity from the sun. As of September 2007, there are roughly 30,000 solar photovoltaic systems installed on homes, commercial buildings and free- standing structures in California. Most systems are connected to the electric grid and provide power to the site. The majority of these systems do not have any battery backup equipment – instead, excess power is sent to the electric utility system.

Solar photovoltaic (PV) systems are installed with an alternating current (AC) disconnect at the service panel. Conduit carrying direct current (DC) power connects the modules to the inverter. The inverter connects the PV system to the utility service panel. AC disconnects are not required in all jurisdictions because the main breaker provides this level of disconnect.

A DC disconnect is installed on the site side of the inverter. Typical systems seen today have an inverter located near the utility service panel. Some inverters (micro inverters, AC modules) are located at the PV module (the solar industry refers to PV panels as “modules”). If the inverter is located at the PV module, the conduit from the modules to the utility power supply is AC. The DC disconnect at the service panel cuts power to the inverter, which is then unable to export power to the utility service panel and prevents any solar electricity from harming service or maintenance workers on the utility side of

the panel. During the day, there is power in the conduit between the PV modules and the DC disconnect.

The systems can produce up to 8 amps and up to 600 volts of electricity which varies by installation. Modules connected together are called strings. Multiple strings are connected together at a combiner box. The power output is highest on a bright day with low ambient temperatures and drops as the modules heat up (such as on a very hot day). There is no power output in the dark and there is no stored energy in the modules themselves. Service lights used by fire crews do not provide enough light to develop any harmful power levels.

Modules are mounted on buildings or on ground supported frames. Roof mounted modules, also sometimes known as panels, can be one of these types:

- Directly on a building's roof
- Integral to the roof system of a building
- On a rack with a space above the roof surface
- On a freestanding structure but not on the habitable structure (such as a trellis or other free-standing support structure)

Specifically:

- Modules attached to a mounting system may be attached to the roof or rest on the roof surface.
- Modules integrated to the roof system are commonly referred to as Building Integrated Photovoltaics (BIPV) and are of two types:
 - Physically integrated roofing products resemble roof shingles or tiles and are installed along with standard roof shingles or tiles so that they blend into the overall appearance of the roof. Physically integrated BIPV modules alternate current as part of a defined roofing system.
 - Aesthetically integrated modules also resemble roof shingles or tiles and are installed along with standard roof shingles or tiles to blend into the overall appearance of the roof. Aesthetically integrated modules do not alternate current as part of a defined roofing system.

Modules are located in a manner to provide the best access to sunlight. This means they are typically mounted on the south or west side facing roof façade. In residential applications, the typical roof area used is about 400 square feet. Larger size systems correspond to a higher site electricity demand. Although it is not advisable to step or walk on any solar system due to slip and/or trip hazards, the systems should be able to support a firefighter's weight.

Other PV products, such as those integrated with a curtain wall or as windows are not currently addressed in this guideline. Other types of solar energy systems that might be seen at a site do not generate electricity. These can be broken down into three major types - solar water heating, solar pool heating, and solar space conditioning. In these

systems, modules and piping usually carry water or glycol. Glycol is used in areas where extended periods of freezing temperature levels could cause ice to damage the solar panels and/or distribution pipes.

Resources

In July 2007 CAL FIRE-OSFM established a Task Force to develop this guideline, working with the California Solar Energy Industries Association (CAL SEIA). Members of local fire service agencies and the solar photovoltaic industry worked together to develop a guideline that would help the fire service ensure safe access to perform rescue and fire suppression operations and aid local government in developing appropriate codes to ensure that solar photovoltaic system installations on residential and commercial buildings are applied in a safe manner.

CAL FIRE: Vickie Sakamoto: vickie.sakamoto@fire.ca.gov
California Solar Energy Industries Association (CAL SEIA): info@calseia.org

Task Force Participants

Significant contributions to the guideline were made by the following individuals:

Fire Service	Solar Industry
Vickie Sakamoto, CAL FIRE-OSFM	Sue Kateley, CAL SEIA
Kevin Reinertson, CAL FIRE-OSFM	Gary Gerber, Sun Light & Power
Matthew Gatewood, Los Angeles Fire Department	Edgar Becerra, Sharp Solar
Denise Enea and Marshall Hird, Woodside Fire Department	Colin Murchie, SunEdison
Jim Hone, Santa Monica Fire Department	John Hostetter, REC Solar, Inc.
Kent Miller, Port of Stockton	Mark Mrohs, Kurt Johnson, Gary Neate, Dylan Anderson, and Carl Lenox, Sunpower
Ken Kwong and Elizabeth Brueck, Sacramento Fire Department	Peter Rive, SolarCity
Lisa Beaver, SMUD	Kirk Uhler and Carl Woods, SolarPower, Inc.
Ron Keefer, Menlo Park Fire Department	
Tim Ippolito, Roseville Fire Department	
Wes Kitchel, Santa Rosa Fire Department	
Scott Poster, County of Los Angeles Fire Department	
Ed Hadfield, Coronado Fire Department	
William Bigariani, San Francisco Fire Department	

Additional Participants

Bill Brooks, Brooks Engineering
John Taeker, Underwriters Laboratories

Adopting the Guideline

This guideline is just that, it is a suggested means of writing a local ordinance and does not have the force of law. Adoption of this guideline is optional. The provisions of this guideline may be adopted by local city, county, or city and county governments to establish more restrictive and reasonably necessary differences to the provisions contained in the California Building or Fire Codes, pursuant to complying with Section 101.8. It may be necessary to amend the wording of this guideline to convert it from a guideline to an adopted ordinance. In accordance with Sections 101.8 and 101.8.1, of the California Building Code, the city, county, or city and county must make express findings for each amendment, addition or deletion of the state building codes. Those findings must be based on climatic, topographic, or geological conditions.

General

Provisions contained in this guideline do not apply unless specifically adopted by local ordinance by a local enforcing agency in compliance with Health and Safety Code Section 18938(b) for Building Standards Law, Health and Safety Code Section 17950 for State Housing Law and Health and Safety Code Section 13869.7 for Fire Protection Districts.

Growing demand for solar photovoltaic products is leading to new products, designs, technologies, and installation methods. As new products and methods become available, local fire departments may encounter solar photovoltaic systems that will require an alternative means of compliance. Solar contractors should contact their local fire department to determine if alternate means or methods would allow for a safe installation that is acceptable to the fire department.

Authorities Having Jurisdiction may approve Alternative Means of Compliance based on their authority, in accordance to California Building Code Sections 108.7 for residential buildings or Section 111.2.4 for occupancies regulated by the Office of the State Fire Marshal. This may be necessary where, for example, new products, designs, technologies or methods become available that provide sufficient alternative protection and access, pathways, and ventilation opportunities for fire crews.

Local Ordinance Required by City, County, City and County, Fire Protection Districts

This guideline does not have the force of law and the provisions of this guideline do not limit the existing authority of city or county governments or Fire Protection districts to establish more restrictive and reasonably necessary changes to the provisions contained in the California Code of Regulations, Title 24, the California Building Standard Codes pursuant to complying with the findings and filings requirements.

Local modifications to California Building Standards Codes must comply with Health and Safety Code Section 18938(b) for Building Standards Law, Health and Safety Code

Section 17950 for State Housing Law, or Health and Safety Code Section 13869.7 for Fire Protection Districts.

Findings and Filings

The city, county, or city and county that wish to amend the current California Building Standards Codes as it pertains to their jurisdiction must make express findings for each amendment, addition or deletion based upon climatic, topographical, or geological conditions.

The city, county, or city and county shall file the amendments, addition or deletions expressly marked and identified as to the applicable findings. Cities, counties, cities and counties, and fire departments shall file the amendments, additions, or deletions and the findings with the California Building Standards Commission at 2525 Natomas Park Drive, Suite 1320, Sacramento, CA 95833.

Findings prepared by fire protection districts shall be ratified by the local city, county, or city and county and filed with the California Department of Housing and Community Development at 1800 3rd Street, Room 260, Sacramento, CA 95814.

Wording

For ease of use, the below listed installation guidelines are worded as requirements. Please remember that these are not legally enforceable requirements, they are just guidelines. To convert these guidelines into a legally enforceable format, a city, county, or city and county must follow the appropriate procedure as explained above.

1.0 MARKING

PV systems must be marked. Marking is needed to provide emergency responders with appropriate warning and guidance with respect to working around and isolating the solar electric system. This can facilitate identifying energized electrical lines that connect the solar modules to the inverter, as these should not be cut when venting for smoke removal.

Materials used for marking must be weather resistant. It is recommended that Underwriters Laboratories Marking and Labeling System 969 (UL 969) be used as standard to determine weather rating. (UL listing of markings is not required).

1.1 Main Service Disconnect

For residential applications, the marking may be placed within the main service disconnect. If the main service disconnect is operable with the service panel closed, the marking should be placed on the outside cover.

For commercial application, the marking should be placed adjacent to the main service disconnect in a location clearly visible from the location where the lever is operated.

1.1.1 Marking Content and Format

- MARKING CONTENT: CAUTION: SOLAR ELECTRIC SYSTEM CONNECTED
- RED BACKGROUND
- WHITE LETTERING
- MINIMUM 3/8" LETTER HEIGHT
- ALL CAPITAL LETTERS
- ARIAL OR SIMILAR FONT, NON-BOLD
- REFLECTIVE, WEATHER RESISTANT MATERIAL SUITABLE FOR THE ENVIRONMENT (durable adhesive materials may meet this requirement)

CAUTION: SOLAR ELECTRIC SYSTEM

1.2 Marking for Direct Current Conduit, Raceways, Enclosures, Cable Assemblies, and Junction Boxes

Marking is required on all interior and exterior DC conduit, raceways, enclosures, cable assemblies, and junction boxes to alert the Fire Service to avoid cutting them. Marking should be placed on all interior and exterior DC conduit, raceways, enclosures, and cable assemblies, every 10 feet, at turns and above and/or below penetrations and all DC combiner and junction boxes.

1.2.1 Marking Content and Format

- MARKING CONTENT: CAUTION SOLAR CIRCUIT
- RED BACKGROUND
- WHITE LETTERING
- MINIMUM 3/8" LETTER HEIGHT
- ALL CAPITAL LETTERS
- ARIAL OR SIMILAR FONT, NON-BOLD
- REFLECTIVE, WEATHER RESISTANT MATERIAL SUITABLE FOR THE ENVIRONMENT (durable adhesive materials meet this requirement)

CAUTION: SOLAR CIRCUIT

1.3 Inverters

The inverter is a device used to convert DC electricity from the solar system to AC electricity for use in the building's electrical system or the grid.

No markings are required for the inverter.

2.0 ACCESS, PATHWAYS AND SMOKE VENTILATION

Access and spacing requirements should be observed in order to:

- Ensure access to the roof
- Provide pathways to specific areas of the roof
- Provide for smoke ventilation opportunities area
- Provide emergency egress from the roof

Local jurisdictions may create exceptions to this requirement where access, pathway or ventilation requirements are reduced due to:

- Proximity and type of adjacent exposures
- Alternative access opportunities (as from adjoining roofs)
- Ground level access to the roof area in question
- Adequate ventilation opportunities beneath solar array (as with significantly elevated or widely-spaced arrays)
- Adequate ventilation opportunities afforded by module set back from other rooftop equipment (example: shading or structural constraints may leave significant areas open for ventilation near HVAC equipment)
- Automatic ventilation device
- New technology, methods, or other innovations that ensure adequate fire department access, pathways and ventilation opportunities

Designation of ridge, hip, and valley does not apply to roofs with 2-in-12 or less pitch. All roof dimensions are measured to centerlines.

Roof access points should be defined as areas where ladders are not placed over openings (i.e., windows or doors) and are located at strong points of building construction and in locations where they will not conflict with overhead obstructions (i.e., tree limbs, wires, or signs).

2.1 Residential Systems—Single and Two-Unit Residential Dwellings

Plan review is required if a system is to be installed that will occupy more than 50% of the roof area of a residential building.

Examples of these requirements appear at the end of this guideline.

2.1.1 Access/Pathways

- a. Residential Buildings with hip roof layouts: Modules should be located in a manner that provides one (1) three-foot (3') wide clear access pathway from the

eave to the ridge on each roof slope where modules are located. The access pathway should be located at a structurally strong location on the building (such as a bearing wall).

- b. Residential Buildings with a single ridge: Modules should be located in a manner that provides two (2) three-foot (3') wide access pathways from the eave to the ridge on each roof slope where modules are located.
- c. Hips and Valleys: Modules should be located no closer than one and one half (1.5) feet to a hip or a valley if modules are to be placed on both sides of a hip or valley. If the modules are to be located on only one side of a hip or valley that is of equal length then the modules may be placed directly adjacent to the hip or valley.

2.1.2 Smoke Ventilation

The modules should be located no higher than three feet (3') below the ridge.

2.2 Commercial Buildings and Residential Housing Comprised of Three (3) or More Units

Exception: If a local fire department determines that the roof configuration is similar to residential (such as in the case of townhouses, condominiums, or single family attached buildings), the local fire department may make a determination to apply the residential access and ventilation requirements.

Examples of these requirements appear at the end of this guideline.

2.2.1 Access

There should be a minimum six foot (6') wide clear perimeter around the edges of the roof.

Exception: If either axis of the building is 250 feet or less, there should be a minimum four feet (4') wide clear perimeter around the edges of the roof.

2.2.2 Pathways

Pathways should be established in the design of the solar installation. Pathways should meet the following requirements:

- a. Should be over structural members
- b. Centerline axis pathways should be provided in both axis of the roof. Centerline axis pathways should run on structural members or over the next closest structural member nearest to the center lines of the roof
- c. Should be straight line not less than 4 feet (4') clear to skylights and/or ventilation hatches
- d. Should be straight line not less than 4 feet (4') clear to roof standpipes
- e. Should provide not less than 4 feet (4') clear around roof access hatch with at least one not less than 4 feet (4') clear pathway to parapet or roof edge

2.2.3 Smoke Ventilation

- a. Arrays should be no greater than 150 by 150 feet in distance in either axis
- b. Ventilation options between array sections should be either:
 1. A pathway 8 feet (8') or greater in width
 2. 4 feet (4') or greater in width pathway **and** bordering on existing roof skylights or ventilation hatches
 3. 4 feet (4') or greater in width pathway **and** bordering four feet (4') x 8 feet 8' "venting cutouts" every 20 feet (20') on alternating sides of the pathway

3.0 LOCATION OF DIRECT CURRENT (DC) CONDUCTORS

Conduit, wiring systems, and raceways for photovoltaic circuits should be located as close as possible to the ridge or hip or valley and from the hip or valley as directly as possible to an outside wall to reduce trip hazards and maximize ventilation opportunities.

Conduit runs between sub arrays and to DC combiner boxes should use design guidelines that minimize total amount of conduit on the roof by taking the shortest path from the array to the DC combiner box. The DC combiner boxes are to be located such that conduit runs are minimized in the pathways between arrays.

To limit the hazard of cutting live conduit in venting operations, DC wiring should be run in metallic conduit or raceways when located within enclosed specs in a building and should be run, to the maximum extent possible, along the bottom of load-bearing members.

4.0 NON-HABITABLE BUILDINGS

This guideline does not apply to non-habitable structures. Examples of non-habitable structures include, but are not limited to, parking shade structures, solar trellises, etc.

5.0 GROUND MOUNTED PHOTOVOLTAIC ARRAYS

Setback requirements do not apply to ground-mounted, freestanding photovoltaic arrays. A clear brush area of ten feet (10') is required for ground mounted photovoltaic arrays.

*****SEE PAGES 13 – 18 FOR EXAMPLES*****

FINAL DRAFT

EXAMPLE 1

Diagram 1: Cross Gable Roof

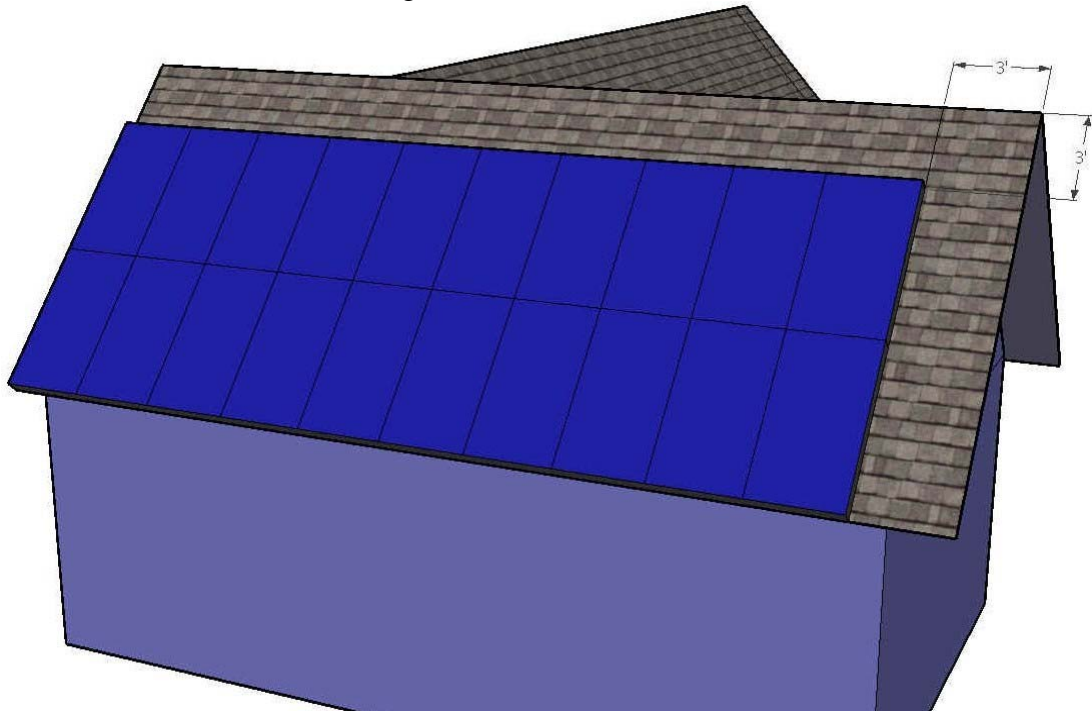

EXAMPLE 2

Diagram 2: Cross Gable with Valley

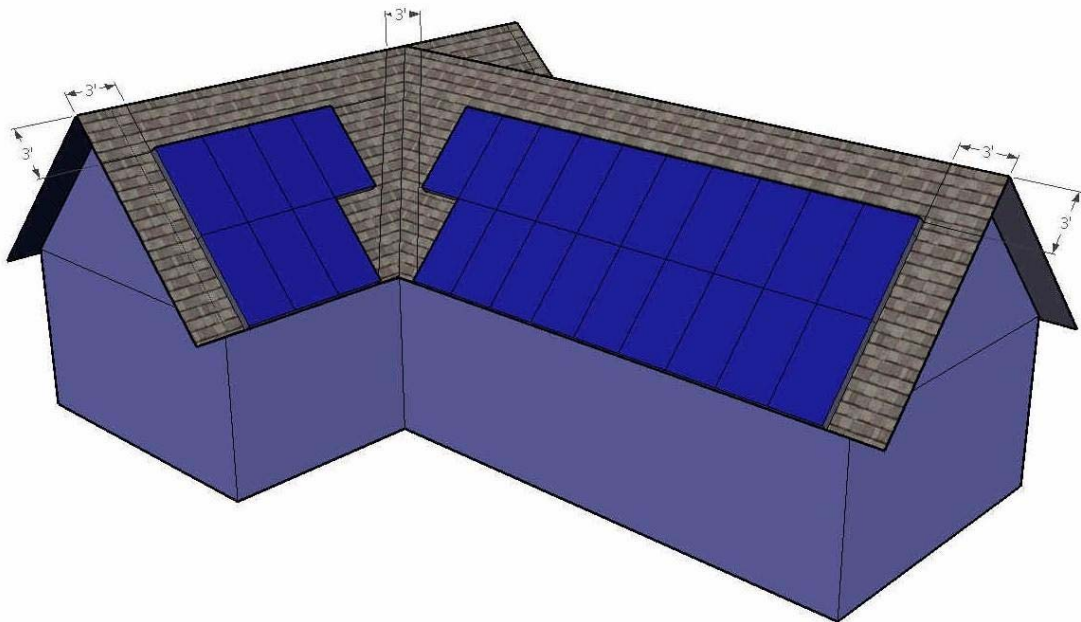

EXAMPLE 3

Diagram 3: Full Gable

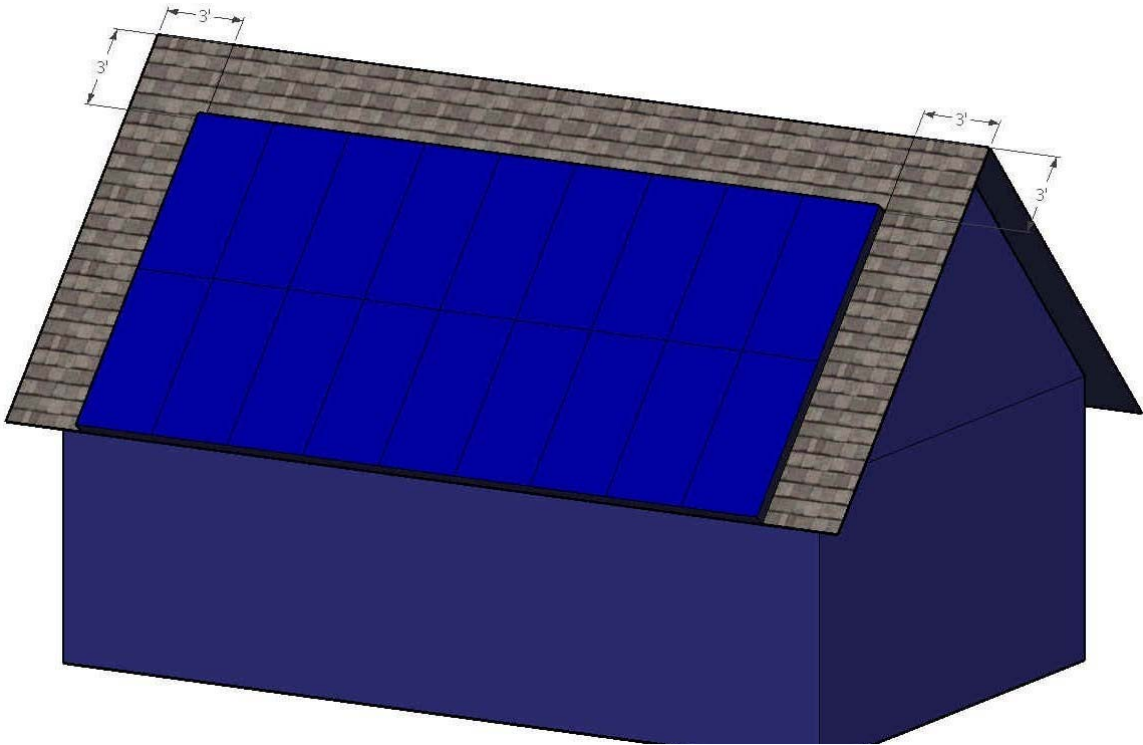

EXAMPLE 4

Example 4: Full Hip Roof

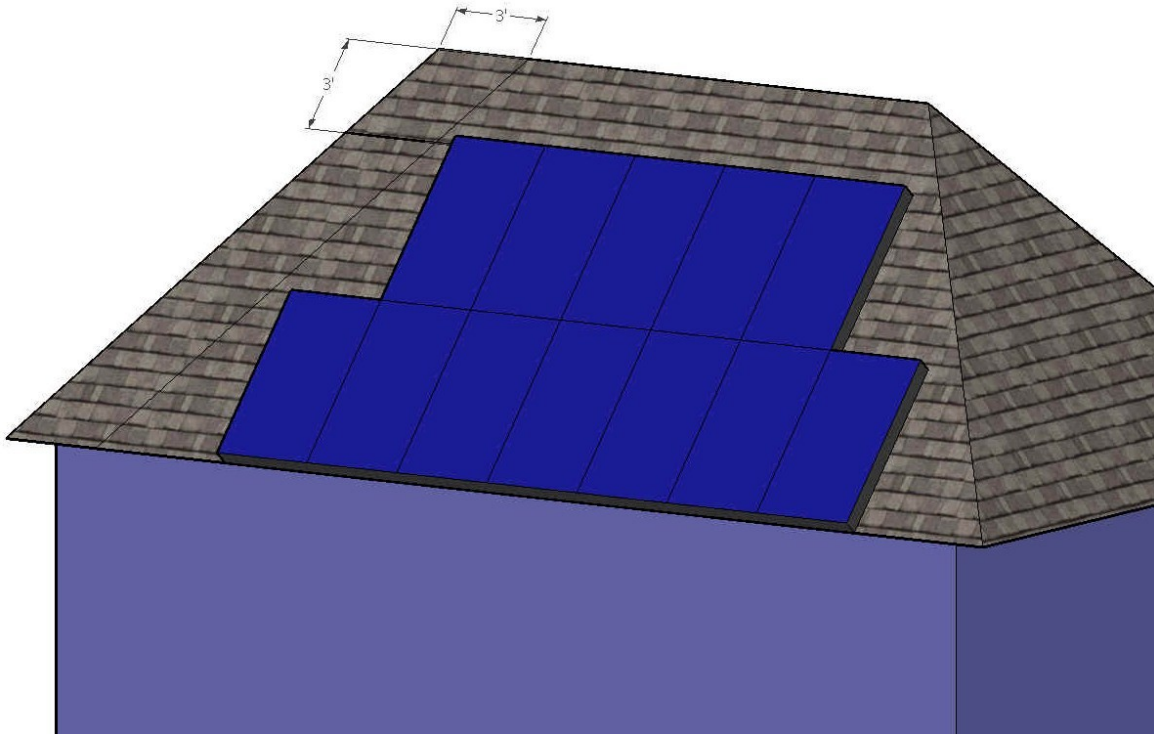

EXAMPLE 5

SOLAR ARRAY EXAMPLE – LARGE COMMERCIAL
8' WALKWAYS

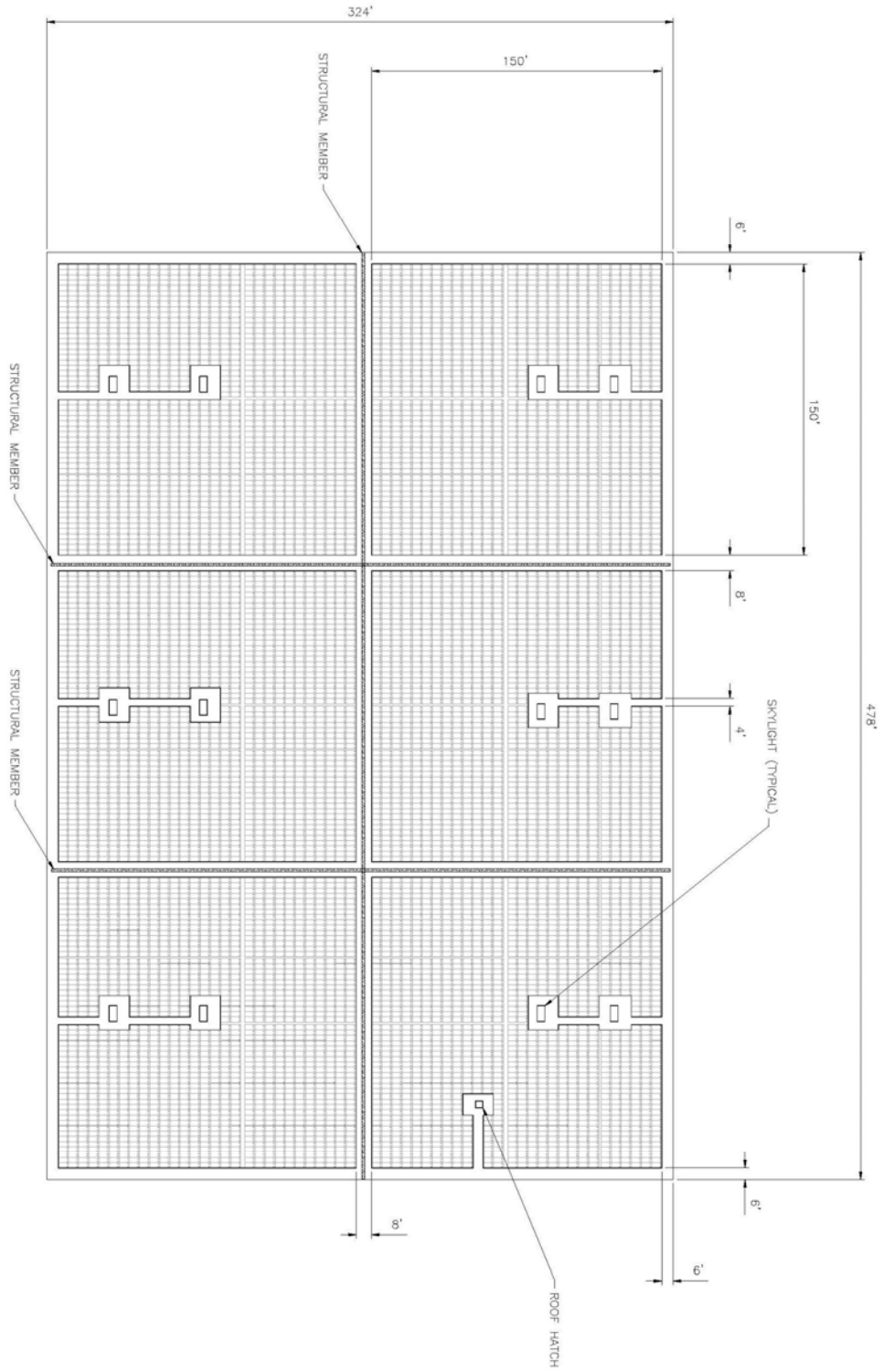

EXAMPLE 6

SOLAR ARRAY EXAMPLE – LARGE COMMERCIAL
4' WALKWAYS WITH 8' X 4' VENTING OPPORTUNITIES EVERY 20'

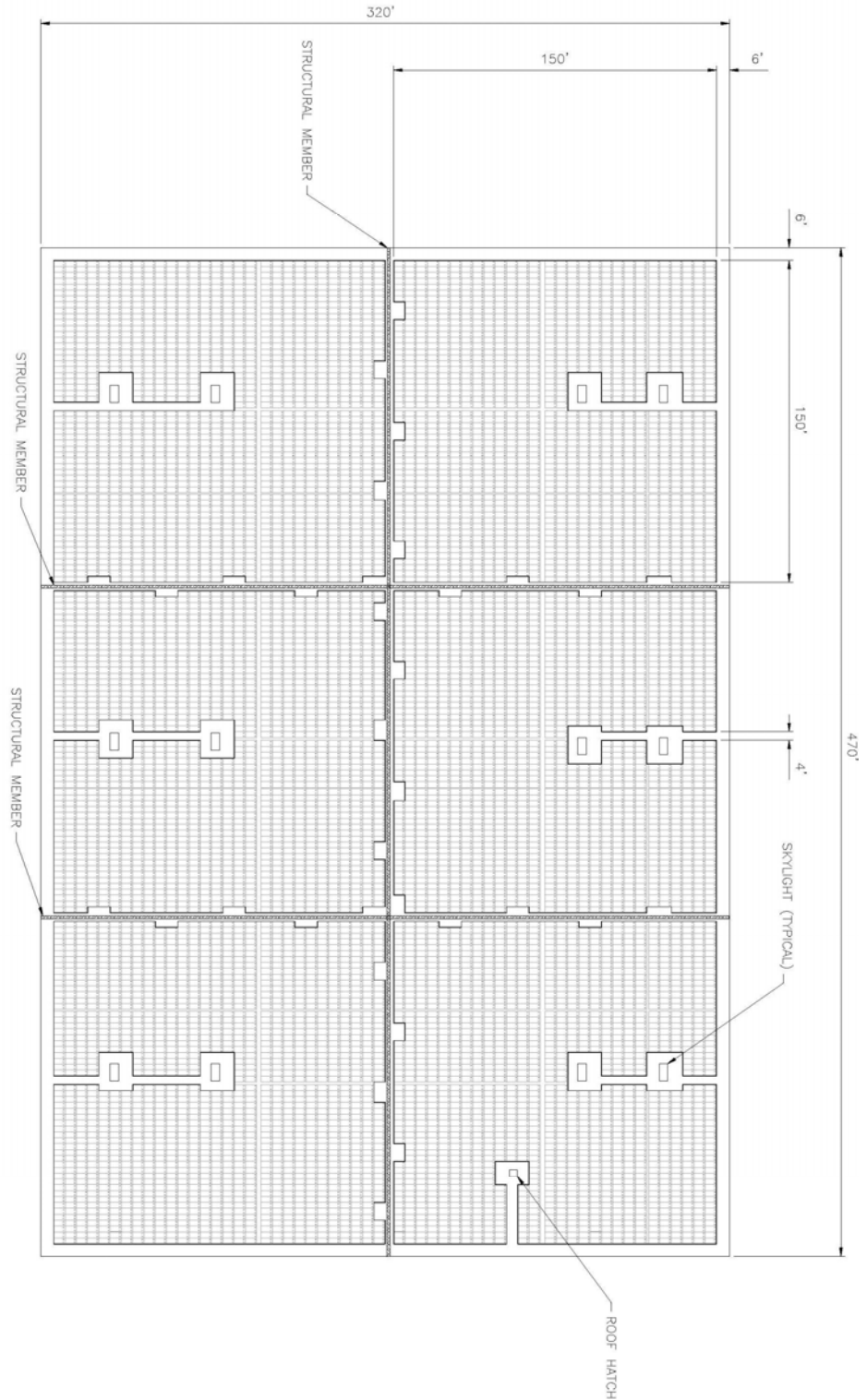

EXAMPLE 7

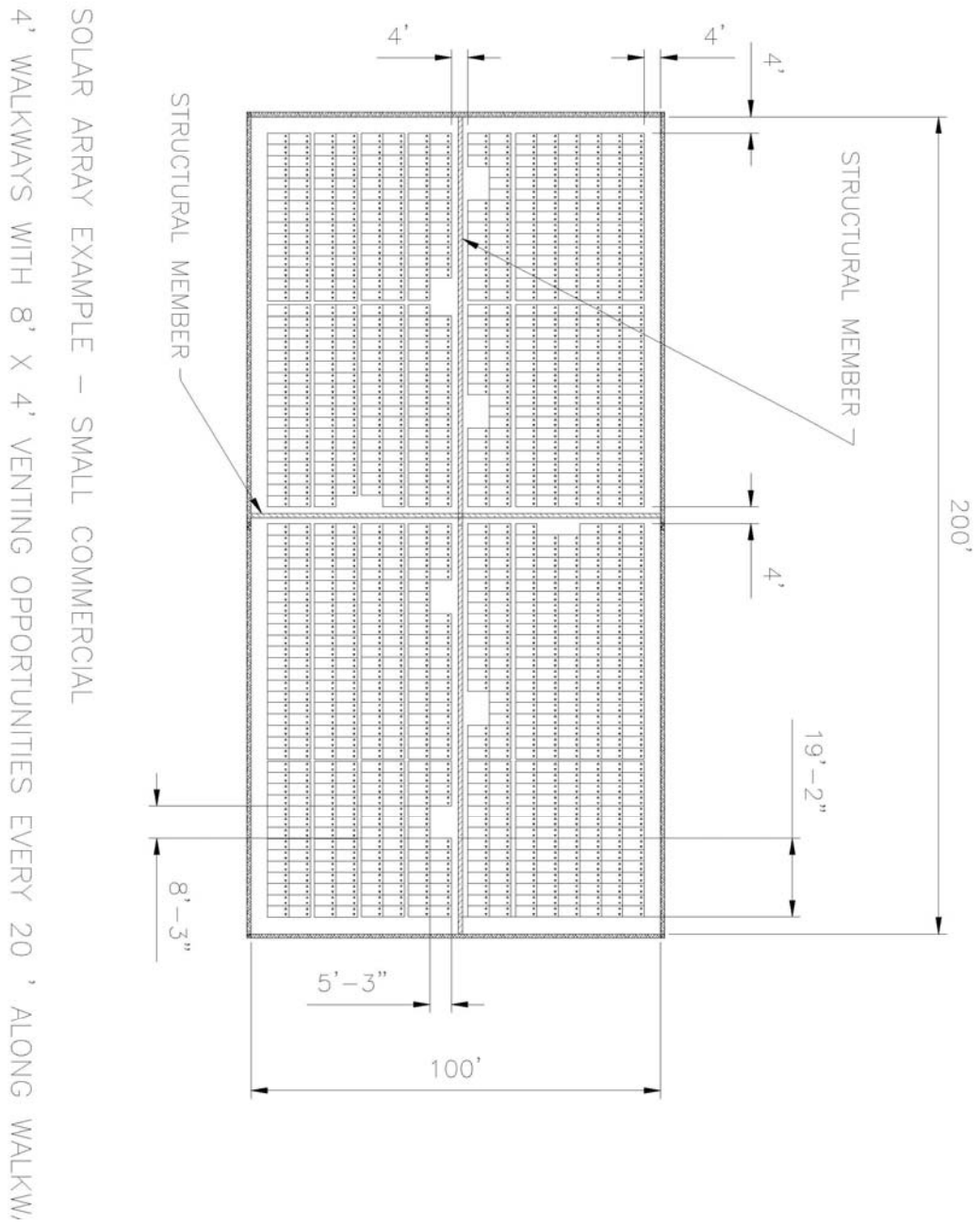

EXAMPLE 8

