

Suntrek's Solar Pool Heating Installation Guide

By Aaron Hill

© Suntrek Ind.

*Congratulations! You are installing a solar heating system that will give you many years of comfortable warm pool water. **Suntrek** solar collectors are made of extremely durable material and will require a minimum of care on your part. Please read all of the instructions and observe a few simple operating cautions to obtain peak performance and maximum life from your **Suntrek** System.*

Designing your Solar System:

1. Measure your pool. Multiply the average length by the average width of your pool to determine the total surface area of your pool. For example, if your pool is 20 ft. x 30 ft this equals a 600 sq. ft pool. *If there is an attached spa, include it's square footage as well.

2. Calculate solar coverage. For every square ft. of pool surface area, you need at least 50% in solar square footage. This is a suggested *minimum* size based on typical heating performance and past customer satisfaction. Larger solar systems can be used to gain even higher temperatures and longer swim seasons. For most applications 80% coverage is *optimum* for comfortable swimming temperatures and a maximum swim season.

3. Consider all possible locations for installing your solar collectors.

You can use any sloped roof that does not face to the north. The most effective orientations are towards the south, west, east and flat. Collectors may be placed on any roof or patio cover. You can place collectors on more than one roof area to gain the desired total square footage. A new structure can be built specifically to accommodate the solar heater. (I.e. a patio cover or a ground mounted rack.) Check for shading of the solar heater location. Direct sunshine hitting the collectors is what produces heat for the pool. Even on a very hot day, a solar heater won't warm the water if it is shaded. Trees may need to be trimmed or cut.



4. Measure the roof. One of the greatest advantages of **Suntrek** collectors are their versatility. Obstacles such as vent pipes can be wrapped around easily. Collectors can also be ordered to any length to maximize your square footage on a small or oddly shaped roof.

We suggest drawing a diagram of the roof, with all measurements top-to-bottom and side-to-side. Decide on how many collectors will fit on the desired area. Each manifold will require 28 inches of vertical roof space. For example, if you have a roof that is 180 inches from top-to-bottom, you can install six collectors (6 X 28"=168"). We advise leaving at least a 12" of roof space at the top and bottom of the solar collectors for the plumbing.

Make a decision about the length of the solar collectors. The collectors can be as long as 50 feet. Keep in mind that the collectors weigh 1 lb. per square foot, so a 2' x 50' collector will weigh about 100 lbs. This can be a difficult factor when carrying up a ladder or across a tile roof.

While it is easier to install a square system, with all collectors the same size, it is better to stagger or pyramid the system in order to keep the collectors entirely on the same area of the roof. This is also the best method for maximizing your total surface area.



Connecting the headers of a staggered system.

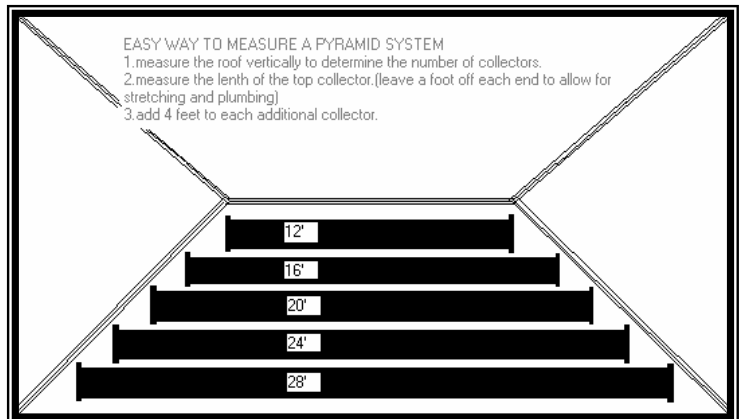

5. Steep Roofs. Structures with a steep pitch can pose additional challenges for a solar installation. Collectors should be installed vertically.

Measure along the top ridgeline to determine the number of collectors to be installed. Next, measure from the top ridgeline to the bottom edge (allowing room for straps and plumbing) to determine the length of the collectors.

Note. Running the collectors close to the top and bottom allow you to make the bottom connections from a ladder rather than standing on the edge of a steep roof.

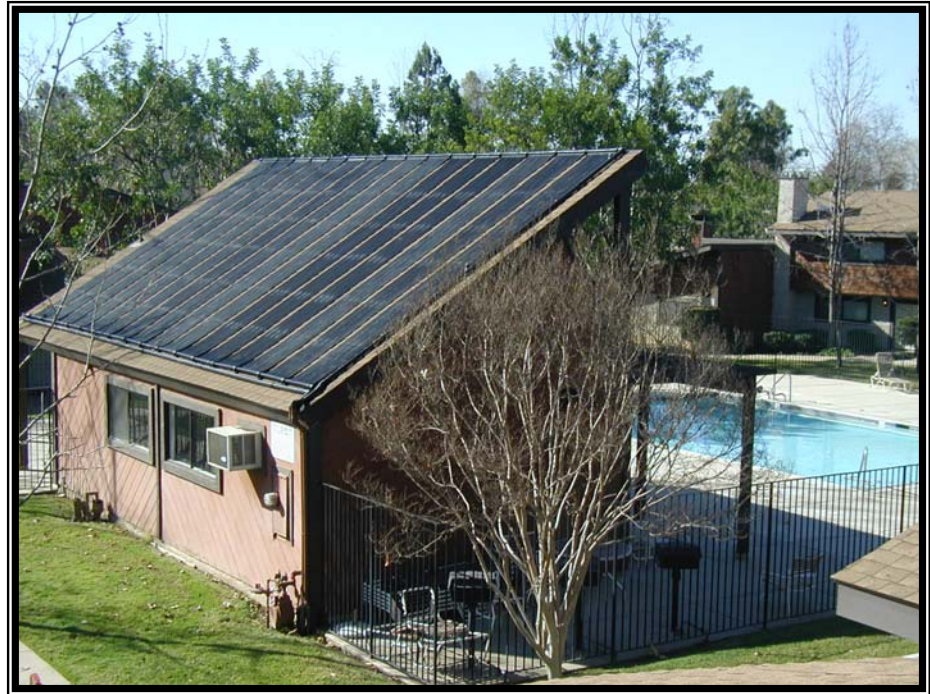

Important! Working on roofs with severe pitches is a dangerous job and should be done by an experienced professional with a competent helper.

6. Plumbing. Consider the routing for the two 2" PVC pipes that will transport the water back and forth between the pool equipment area and the solar heater. There is usually more than one way to accomplish this. If the pool equipment is not right next to the structure where the solar heater will be installed, the feed/return pipes are typically buried underground.

Important: The solar heater should be plumbed so that the water in the solar collector can gravity drain back to the pool every day once the filter pump has turned off. This can usually be accomplished by running the feed pipe (if not both pipes) up to the lowest part of the system.



This iron fence was modified to accommodate our solar piping along the top.



Matching paint can do wonders for camouflaging your pipe run.



Flexible PVC was used to hide the pipes behind this brick archway.

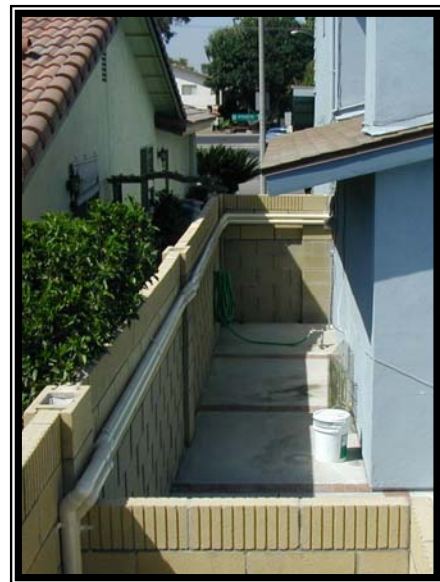

7. Tools and Equipment needed:

1. Sturdy ladder
2. Power drill
3. Tape measure
4. Calking gun
5. Tube of roofing mastic (Henry #208 is best.)
6. PVC primer and glue
7. 2" PVC Saw or hacksaw
8. 2" PVC pipe and fittings
9. Torpedo level
10. Sharp razor knife
11. 5/16" and 7/16" nut drivers
12. 1/4" masonry drill bit
13. Teflon tape
14. 1/4" Galvanized lag bolts (1 1/2" to 3" in length, depending on roof type)
15. #10-12 plastic anchors for lag bolts
16. Flat black spray paint
17. Paint to match house color.

Note: It is assumed that you are familiar with cutting and gluing PVC pipe. If not, we recommend getting instructions from your pool supply center. It is not difficult, but a little experience helps.

*If you plan to install these for a living I strongly suggest investing in a good cordless hammer drill and a pair of 2" PVC cutters. A complete list of the tools and materials we keep on our installation trucks can be sent via fax or e-mail upon request.

Important: Consult your local building department prior to installing your solar heating system; a building permit may be required. The national testing lab for solar pool collectors in the USA is the Florida Solar Energy Center. The building department may ask for Suntrek's official certification number. That number is FSEC 92012.

For assistance in sizing or ordering, The **Suntrek FREE HELP LINE** is:

1-800-2-WARM-IT

(Pacific Time business hours)

For assistance outside the USA, please use our e-mail at ceo@suntreksolar.com



SUNTREK
 Your Solar Energy Company

Certified to
 NSF/ANSI Standard 50

Certified for Pools and Spas
 Model: Suntrek • Batch Code: _____
 Max PSI: 20 • Max Head Loss: .008 per S.F.
 Max Design Flow Rate: 2 GPM/10 S.F. • BTU: 1024 SF/Day
www.suntreksolar.com

Parts for Assembling Suntrek Solar Collectors

Solar Collector Tubing



Collector Coupling

Suntrek Manifold

CPVC Adapter



Stainless Steel Clamps

The NSF/ANSI Standard 50 Certification is only for the solar collector (manifold, tubing, CPVC adapters, and hose connectors) and does not include any other components. Any additional items required for installation, such as three-way valves and vacuum relief valves, are separate from the Certification and should carry their own applicable Certification(s). Only the items shown on page 6 are included in the Certification.

Collector Installation: Composition Roofs

*Of all the possible solar applications, the composition roof is probably the easiest of all for installing **Suntrek** collectors. The rubber mat glues well to the roofing surface and strapping penetrations are simple and trouble free when done properly.*



This system was installed on a new flat composition roof. We worked with the roofer to have two 20' 2x4s sealed under the cap sheet for added security against leaks. All strapping will be bolted to these.

1. Line up all collectors so that the manifolds are touching and are in a straight line. Don't roll them out more than a foot or two.



2. Attach an adapter to each end manifold with a rubber coupler and two stainless steel hose clamps.

3. Continue connecting all manifolds in the same manner. Straighten them out when all are connected.



4. This system had to be split into two banks to go around some skylights. Connect the manifold gap with a piece of pipe and two 2" PVC couplings.

When you've determined the length of pipe needed, cut another the same size and glue on a pair of couplers & adapters. This will be used to bridge the other end.

5. Manifolds all connected and ready for strapping. →

** Strapping is a very important part of solar collector installations. Most problems that may occur years later are due to not properly attaching the system.*



← Collector straps are made of a strip of collector material five tubes wide by about 20" long, one stainless steel washer and for this job 1/4"x2" galvanized lag bolts will be used. (Bolts not included in installation kit.) Run the bolt through the middle tube so that 1/4" of the strap extends past the washer.

6. Apply a small amount of roofer's mastic where you plan to make your roof penetration. Directly to the side of the coupler, about 4" out. →



← 7. Wrap your collector strap around the coupler and drive the bolt through into the block.

** If you are not using mounting blocks take extra care not to over tighten the bolts. Most composition roofs are mounted on 1/2" plywood and the penetrations are easy to "spin out". Start the bolt applying a good amount of pressure and the bolt will grab the wood right away. Tighten just enough to squish the rubber with the washer. If you do over tighten your bolt you'll feel the bolt suddenly spin easily in place as it strips out the wood. If left alone the collector will eventually pull the strap out, leaving a hole in the roof and an unsecured section of the collector bank. Pull out the bolt, seal the hole and try again to the side.*

Close-up of properly fastened manifold strap. Trim off excess strap.

** Note placement of stainless steel clamps, allowing access to the screws beneath the strap.*



← Manifolds all secure, collectors ready to be rolled out.

8. Blow or sweep the collector area. This isn't usually necessary on a pitched roof but a flat roof will collect a lot of debris. If a roof is particularly dirty, you may need to hose it off and wait for it to dry. The mastic won't adhere well to a wet or dusty surface.



Unlike shingled roofs, this one has no tile line to follow, so we snapped a chalk line to help us get our first collector straight.



9. Apply a line of mastic every three feet. Make no more than two lines per 10oz. tube, otherwise you'll not be using enough to properly secure the collectors.

10. After applying mastic for one collector, roll out the collector, pulling it tightly as you go. →

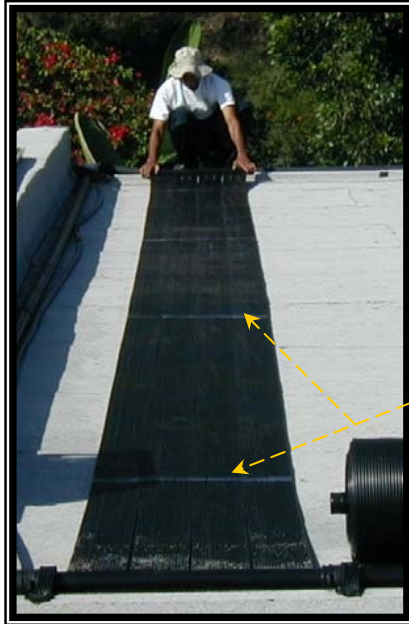

11. Immediately after rolling out the collector, grab the manifold at each end and pull the collector until you see the rubber at the far end start to straighten out.

← At this point you can remove that tape as well.

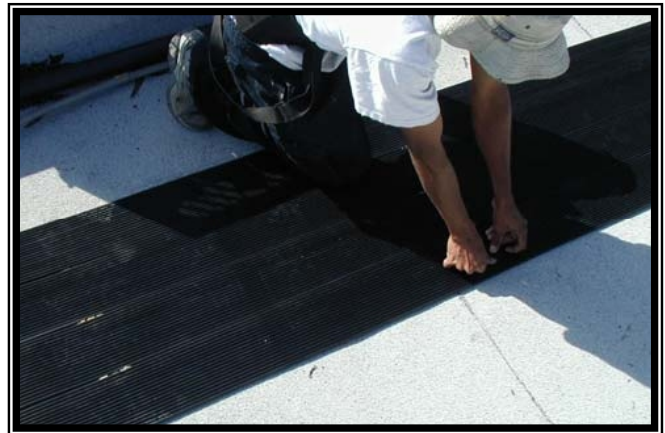

12. Go back over the collector and press the rubber into the mastic, straightening it out as you go. This is essential to insure good adhesion to the roof. →



← * On a pitched roof, especially on a hot day, you may have to go back periodically and push the rubber back into place until the mastic starts to set up.

13. Continue rolling out the rest of the collector bank in the same manner. You shouldn't need to snap any more chalk lines. Just go off of the previous collector. Make sure your manifolds touch each other and are straight. →

* As the day progresses, especially if it heats up, you will notice the collectors looking a little funny. **DON'T PANIC!** As the fresh rubber heats up it expands and buckles up a bit between the mastic lines. They will shrink back as soon as you run that cold pool water through them. **DO NOT** try stretching the collectors to make them lay flat again. They will eventually shrink back to their original cold length.



14. Connect the pipe you made up in step 4 before rolling out the remaining collectors. You may also want to snap another chalk line in order to get the next collector straight.

15. Once all of your collectors are rolled out, connect and strap them as you did the other end. →



Install the vacuum relief valve to the high corner, opposite end of your return pipe.

It goes directly into a rubber coupler and is secured with a stainless steel clamp.



The vacuum valve is sold separate and is not included as a component of the NSF/ANSI Standard 50 Certified solar collector. An NSF/ANSI Standard 50 Certified valve should be used in applications requiring Certification.

Schematic for plumbing the system.
 Feed pipe goes to the lowest point of the system while the return comes off the opposite high corner.

** All plumbing should be done with 2" schedule 40 PVC pipe, witch may be difficult to find in black like we use, but white pipe can easily be painted. Schedule 80 PVC is another option. It has a dark grey color but is heavier and more expensive. Whatever you do, don't be tempted to use black ABS pipe. ABS is not intended for this type of application and will cause you endless headaches down the line.*

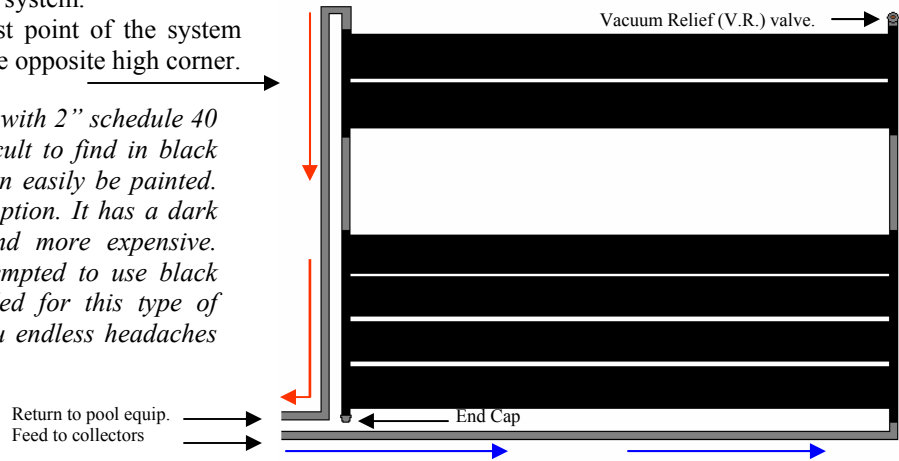

Paint all pipe, (if you couldn't get black PVC) fittings and mastic that shows with flat black spray paint.



All roof work complete.

Flat Roofs:

Flat roofs pose a particular leak hazard. Water tends to puddle in some spots, which can corrode your strapping bolts and cause leaks. It is recommended that any lag bolt on a flat roof be stainless steel. While the techniques in this guide have been proven effective, the fewer the penetrations the better. Here are some safe strapping alternatives to penetrating the deck of a flat roof.



Collectors can be ordered in lengths that allow you to wrap your straps around the fascia.



Straps can be made extra long so the bolts can go around the edge of a flat roof.



Straps can be lagged onto a parapet wall.



Tile Roofs:

As long as you can walk on the roof without breaking each tile, a tile roof is our most common application in many parts of the world. Painting the collectors to match the roof color is common for installations that are visible from the front of the home.



1 After connecting all the manifolds on one end, drill a hole in the tile about 3in. from the coupling. Use a 1/4" masonry drill bit. Try not to let the drill bit connect with the roofing felt underneath the tile.



2. A plastic anchor inserted in the hole will be used to secure the manifold straps.



3. The rubber of the manifold straps creates a good gasket seal around the tile penetrations and does not require additional sealant.



When attaching to a curved tile roof never drill into the valley of the tiles. All rain water is channeled through the valleys and greatly increases your chances for a leak.

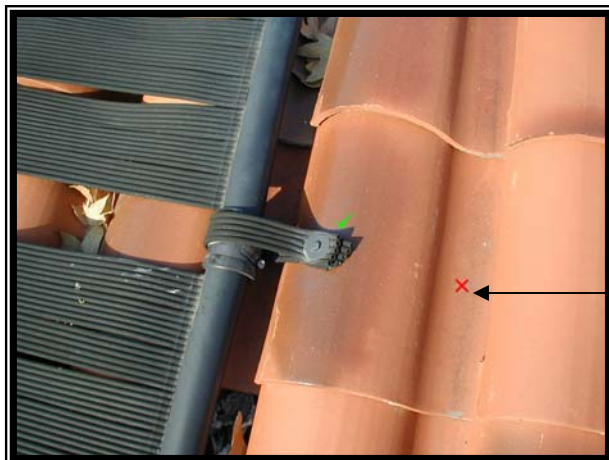

4. As you would a composition roof, run your mastic lines every 3ft. →



← 5. Straightening out the collectors is a little trickier on tiles but not too difficult to master.

6. otherwise, a tile roof is installed like any other. →



← *a curved tile roof should be glued at every other tile, requiring about 50% more mastic.*

Collector strapping:

Some applications require the collectors to be strapped rather than using mastic adhesive. These include tar & gravel, wood shake shingles, patio covers, ground mounted racks, or any roof you plan to replace in the near future.



Tar & Gravel Roofs:

1. line up and connect your collectors in the same manner as on page 7.

2. Use a hammer claw to scrape back the dirt and gravel until you have exposed a 2" area of tar directly behind each coupling. Otherwise, Your manifold strapping is done in the same manner as on page 8.



3. After all manifolds are secure, roll out collectors. Connect and secure manifolds on the other end.

4. Using the collector material provided in the installation kit, separate the tubes in groups of four to make the collector straps. Lay them out across the collectors every four to five feet.



5. When bolting straps, take care to use plenty of roofing mastic and not to over tighten the bolts. If the bolt spins in place, it will pull out easily and cause a potential leak. Tightening just enough to squish the rubber strap is sufficient.

Keep the collectors as straight as possible but don't worry if they sag a bit when the sun starts to warm them up. You can straighten them up while you strap them.

Start strapping by bolting the strap ends at the top and bottom of the system.



Between each collector, where the straps cross the 4 inch gap, scrape back the dirt and gravel until you have exposed tar directly under the strap.



Secure the straps between each collector, straightening out the collectors as you go.

6. Add a small line of collector adhesive directly under the straps this will keep the collector strips from sagging over time.



Use some flat black spray paint to cover any mess caused by the mastic.

Wood Shake Shingles:

Although you use the same basic strapping technique, there are some added considerations you need to be aware of when strapping your collectors.

The shakes are too weak and thin to screw a lag bolt into itself. You have to screw into the wood supports underneath.

In order to reach the wood under the shingles, you will need longer lag bolts. 4" should be fine.

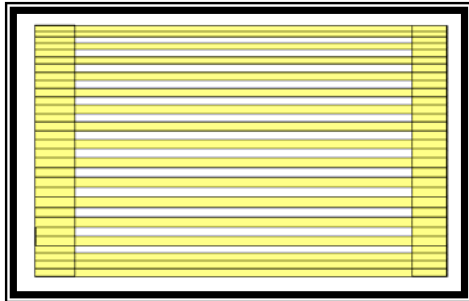

Stringers and eaves shown in yellow.

If you line up your collectors along the eaves you'll be sure to easily find wood for your manifold straps. The diagram shows how you may have to run your straps to find wood.

Shake shingles are usually supported by 1"x4" lumber, called "stringers", spaced 4" apart. Around the eaves, the wood is butted together. If you try screwing a lag bolt where there is a gap between stringers you will find that the lag bolt spins freely without cinching down the strap. The bolt will have to be moved over a bit until you find the stringer.

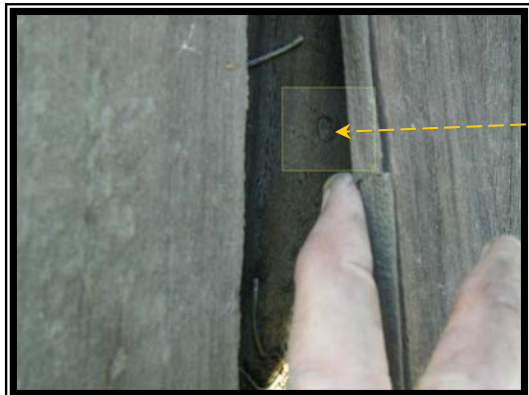
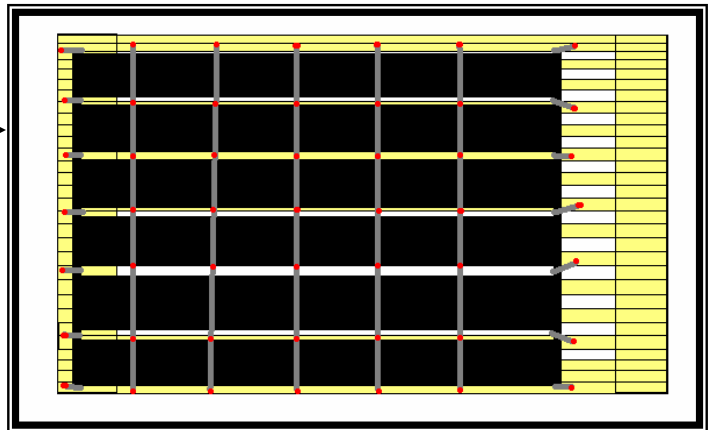

A good way of estimating where the stringers are located is to lift up a shingle near where you would like to drive a bolt and look for one of the roofer's nails or staples.

Patio Covers:

If your patio cover has a finished roof, use the same techniques as earlier described to attach the collectors.



A conventional, open slatted patio cover, requires a premium grade shade cloth to be attached on top for added support for the collectors. Use 3/8" T-50 staples every 6in. or less along every beam and 3in. or less along the edges of the shade cloth. A roofer's hammer stapler makes this an easy job and along with the shade cloth can be purchased at your local hardware-home supply warehouse.

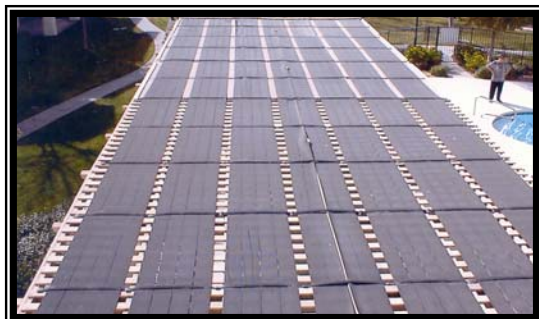

← If the slats are close enough together shade cloth won't be required.

Ground Mounted or Hillside Racks:

A great alternative to mounting collectors on your house is to utilize some unused property like a hillside.



1. Use four stakes and some neon colored string to mark the perimeter of the rack. The most important thing here is to get the top and bottom lines parallel and even with each other when looking at them from behind. →

Getting the rack as low as possible was a priority for this customer so we had to do some shoveling to bring down some high spots in the hillside.

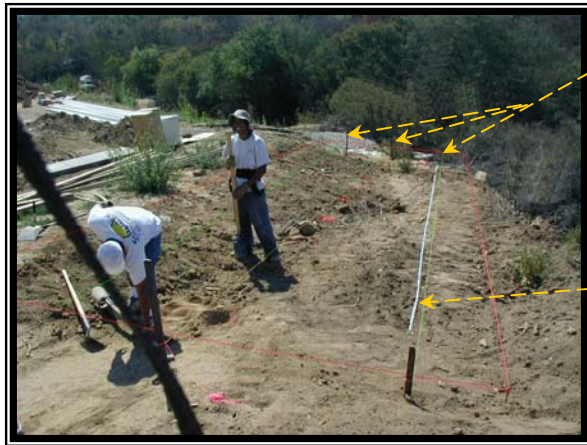

2. Drive three pairs of stakes outside of the perimeter for the post hole lines (highlighted in green). One at the center and the others about two feet from the top and bottom. Have your post lines lightly touch the sidelines as they cross to the other side. These will line up the post holes and later be used to determine the height of each post.

3. Lay out a measuring tape. Starting from about two feet in, use some marking paint to mark the post hole locations every five feet. You can now get your men to work digging post holes.

4. Your post holes should be slightly off center, up the hill from the post line and at least 18" deep. →

5. Mark on a sheet of paper a number representing each hole. Measure the depth of each hole up to the post line and write the length under it's corresponding number.

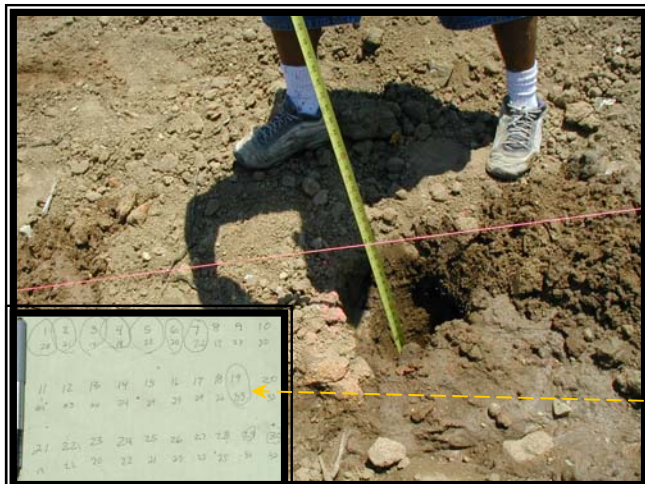

6. As you cut each post, mark it's hole number on one end with a magic marker and circle it on the paper.

7. Coat the posts with **Henry 204 Asphalt Emulsion** or whatever wood preservative you choose. →



8. Place posts in their corresponding holes and lay out the 2x6 joists. ←

9. Line up the joists just under the post lines and use 3" lag bolts with washers to secure to the posts. We use two bolts per post. →

** Pre drilling the joists will help to prevent snapping the bolts.*

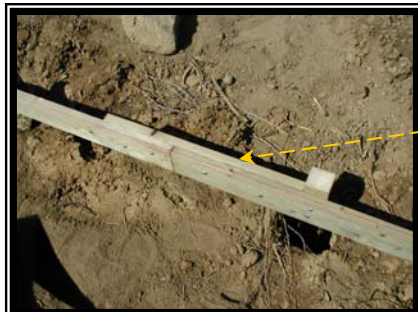

Using a 2ft. 2x6 to piece the joist ends together.

10. These 2x4's are attached temporarily to hold the joists and posts straight and upright. They will be removed after the cement has been poured and set overnight. —————>



11. Time to pour cement.

**Take extra care not to bump into the rack. The fresh cement cracks easily and the rack will become wobbly.*

← Let posts set overnight.

Remove 2x4's when posts have set.

12. Trim and seal posts. —————>



13. Attach the end beams first making sure the ends touch the top string line. These beams will be where the collector manifolds are secured and should be spaced 6in. beyond the actual collector length.

At this point you only need to screw to the top joist. (It will be to square them up when all of the beams are in place.)

Next, lay a tape measure across the top joist and mark it every 18in.

14. After cutting all beams to size,(14ft. for this six collector rack.) bolt 2"x4" beams to the top joist while lining them up with the string line. Use only one 3" lag bolt & washer.

String line can be attached to the end beams once they've been bolted to the joist.

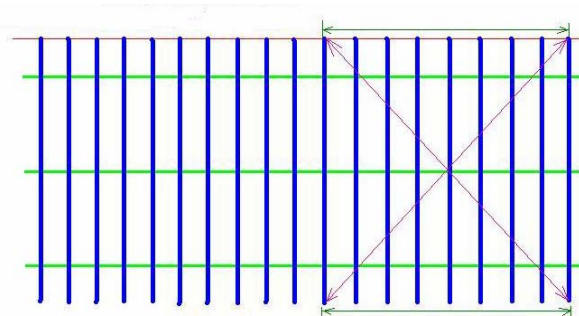

15. Before the beams can be secured to the other two joists, they need to be squared up to the top string line. Here's an easy method.

Using the first beam and one of the inner beams, adjust them until their two diagonal measurements are the same while staying parallel.

16. Now you can finish bolting the first beam. Measure the rest from below, 18" apart, and finish bolting the rest of the beams to the other two joists.



17. Using 4" lag bolts & washers, attach a 2"x4" to the end of each beam along the top and bottom

This is a good time to run any plumbing that you want hidden under the rack.

18. Cover the rack with shade cloth in the same manner as described for patio covers. Wrap the cloth around the edges for aesthetics.



19. Connect and roll out your collectors.



20. Run a strap along every third beam.



21. Finish plumbing.



Collector Modification:

*One of the greatest advantages of installing a flexible EDPM rubber **Suntrek** system is its ability to be wrapped around obstacles such as plumbing and attic vents. Wrapping the collectors around corners is also a good way to maximize the collector area without complicating the plumbing by splitting the system.*

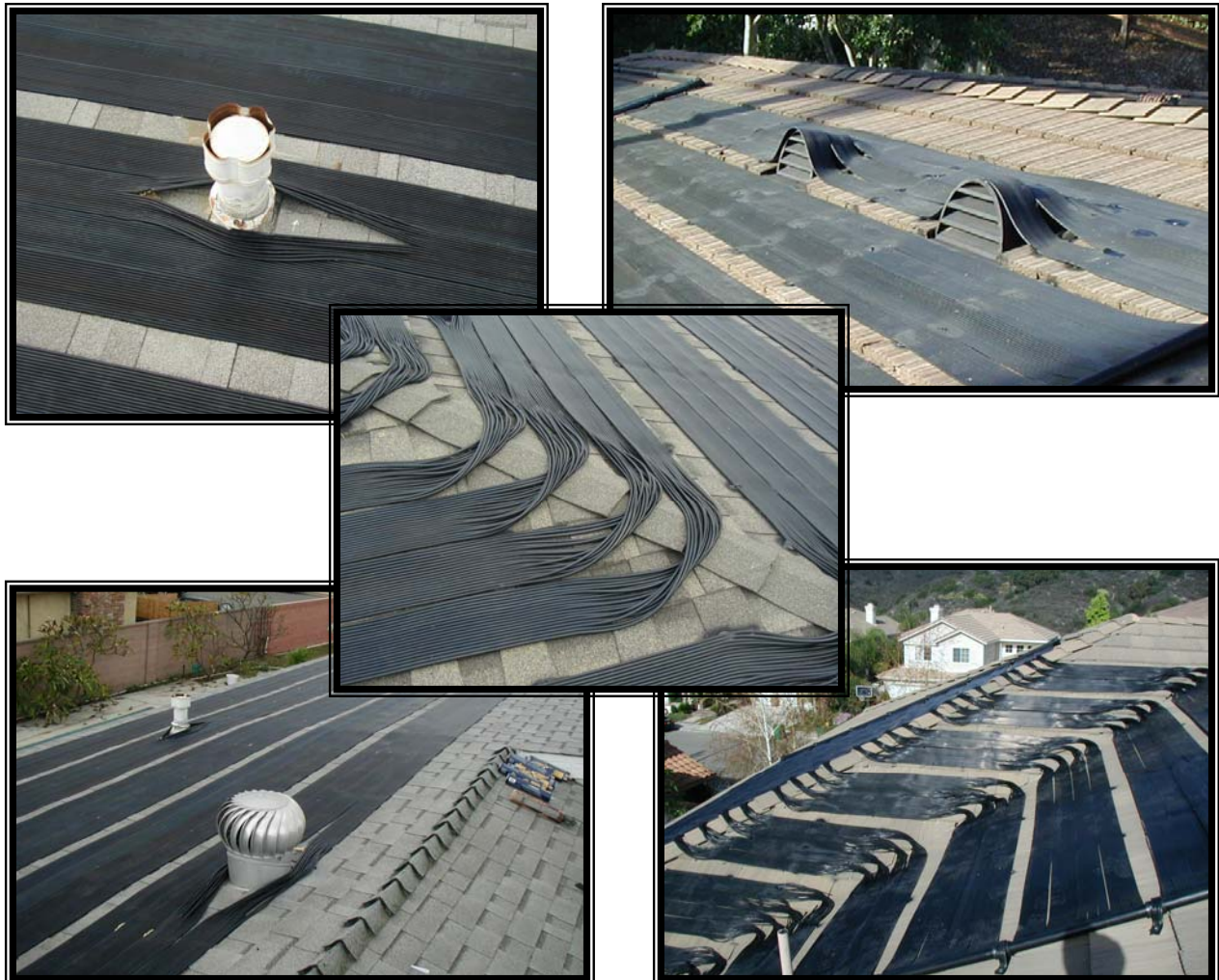

Measuring for a wrapped system:

Inside wrap:

1. Measure the roof vertically to determine how many collectors will be installed.
2. Measure the length of the top collector .
3. Subtract 4ft. For each additional collector.

Example: Suppose the top measurement (shown in blue) is 35ft. Collector #1 will be 35ft., #2 will be 31ft., #3 will be 27ft., #4 will be 23ft. and so on.

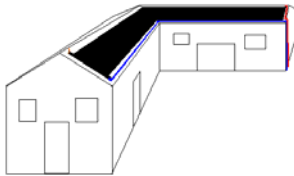

Inside wrap.

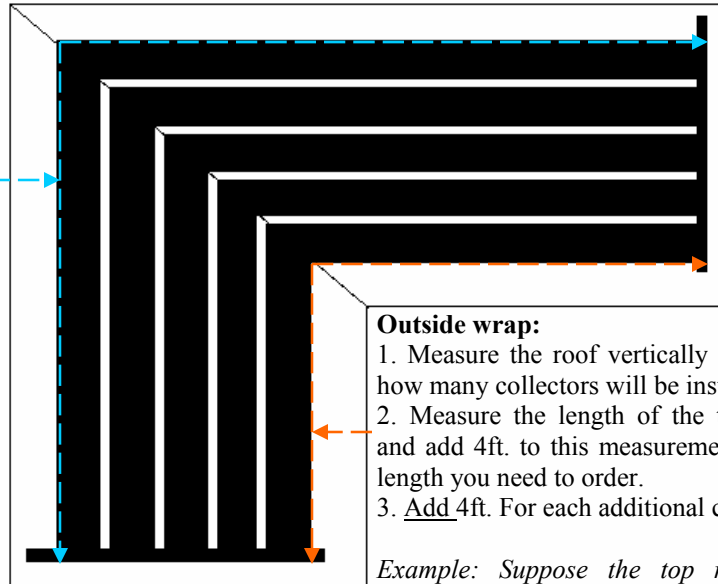

Outside wrap:

1. Measure the roof vertically to determine how many collectors will be installed.
2. Measure the length of the top collector and add 4ft. to this measurement to get the length you need to order.
3. Add 4ft. For each additional collector.

Example: Suppose the top measurement (shown in orange) is 15ft. Collector #1 will be 19ft., #2 will be 23ft., #3 will be 27ft., #4 will be 31ft. and so on.

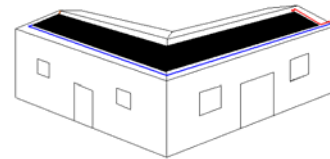

Outside wrap.

Zig Zag wrap:

1. Measure the roof vertically to determine how many collectors will be installed.
2. Measure the length of the top collector.
3. All additional collectors will be the same length.

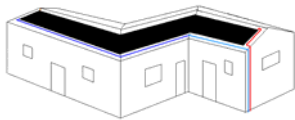

Zig zag wrap.

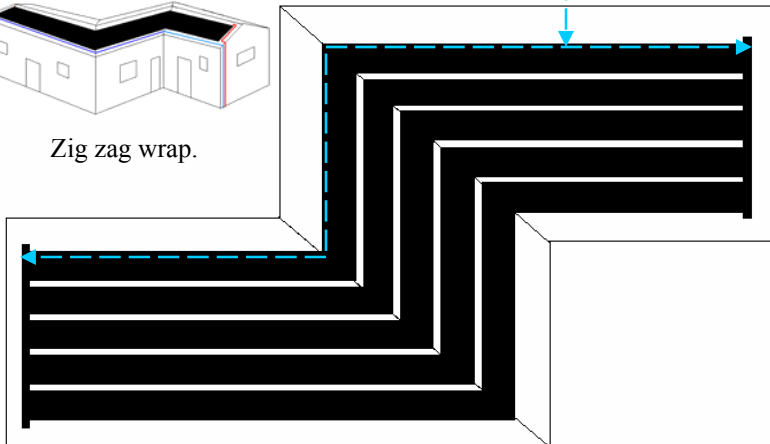

** When ordering , request that one manifold be left off of each collector. They will have to be attached after the collectors are rolled out.*

1. Line up , connect and secure manifolds.



2. Apply mastic up to 2ft. from the first corner.



3. Roll out collector , past the corner, until completely rolled out. Remove the tape.



4. straighten out where there is mastic.



5. Spray silicone on the collector above the corner.

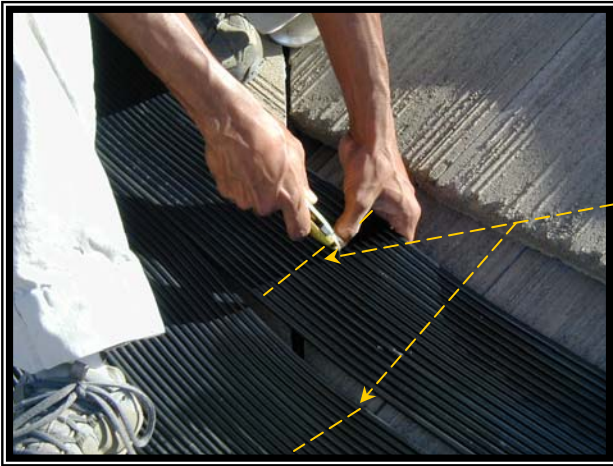

6. Using a sharp utility knife, carefully slice between each tube (about 2in.) directly above where the collector strip crosses the corner.

7. Pull back the rubber a couple feet to give you some slack to work. (Try not to disturb the area that you previously glued.) One at a time separate each channel, about 18in. each side of your cuts, as shown.



8. After all the tubes are separated, straighten the collectors enough to take the slack back out of the corner.

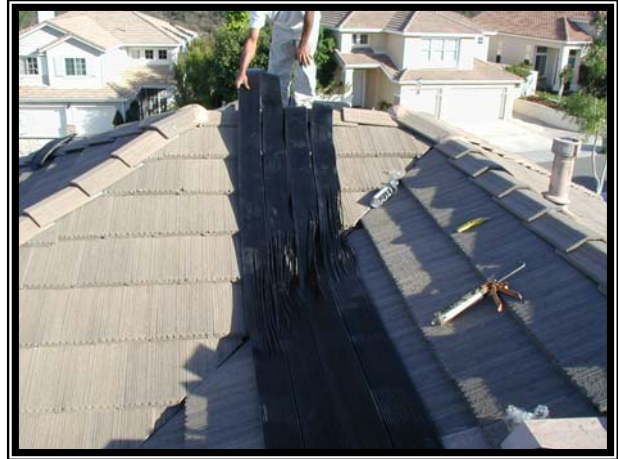

9. Apply mastic to the next section of the roof.



10. Starting from the lowest section of rubber, turn the section over and run it along the next section of roof. Take extra care to be sure the collector stays the same height on the roof as it wraps around the roof.



Continue the same with the other collector strips as shown.

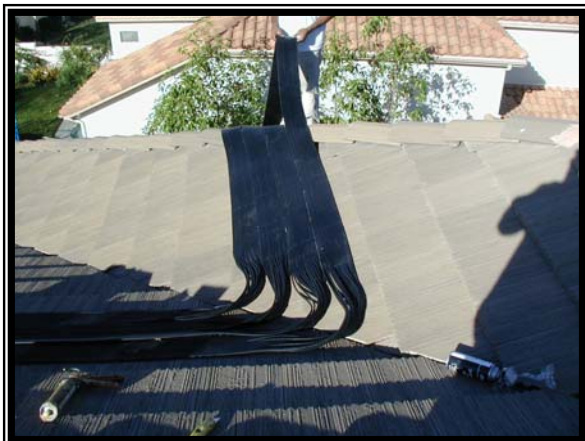

If this were a single corner system, the collector would look like this on the end and the strips would have to be cut to the length of the shortest piece. This system however, has a zig zag formation so the rubber will line back up after going around the outside corner.



Use the same method to split the channels and turn the corner for the outside wrap as you did on the inside.



This better shows turning the strips as you wrap around the corner.

It helps to have a helper hold down the corners as you roll out the strips and straighten out the collectors. →

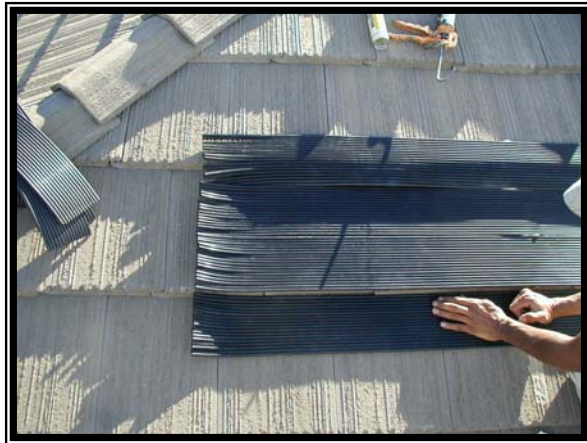

← If you do a good job of wrapping the corners on a zig zag system your collector will line up like this on the end and you won't have to cut off any excess rubber.

If you do a great job they will all line up like this. →

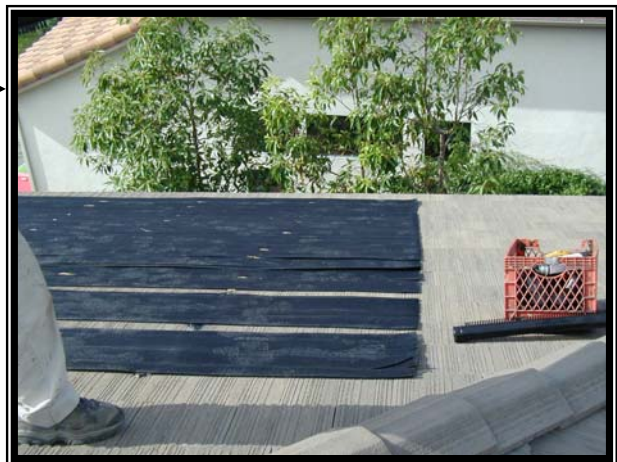

By using the zig zag formation for this job, we were able to add 56 square feet more collector area while saving the cost of 24 manifolds, 48 couplings, 96 clamps, 48 straps, 48 pipe adapters, 90 fittings and about 50ft. of pipe.

Use the same channel splitting technique to wrap around any heater or plumbing vent. Painting the vent flat black will make it look better from below. →



When going over these dome attic vents, or around any obstacle over 18in., you need to order 1ft. of extra collector length for each obstacle and order the collector with one manifold left off. This will give you plenty of extra material to wrap neatly around these vents and still allow you to have the manifolds all line up.

Channel Repair:

It's not uncommon, when splitting channels, to accidentally cut into a channel with your utility knife. This can easily be repaired with one of the collector splicers included in your installation kit. Simply cut the channel where the damage is, lubricate the ends and the splice with silicone spray and re-connect as shown. →



Connecting manifolds onsite:

Some installations require you to order some or all of the collectors with one manifold left off and be connected at the jobsite.

1. Snap a chalk line where you will be cutting the rubber. →



← 2. Use a sharp utility knife to cut the rubber to size.

3. Refer to the **collector assembly instructions** for connecting the manifolds. →

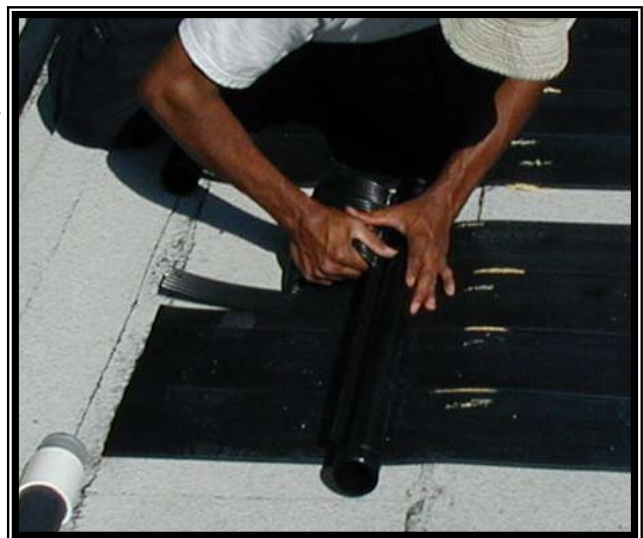

Plumbing The Solar At The Pool Equipment:

At first glance pool equipment can be intimidating. Although no two look alike, when you understand the basics, they are all the same when it comes to the solar tie-in.

*Red arrows indicate flow with solar on.
Blue arrows indicate solar bypass flow.
Yellow lines indicate how the plumbing was prior to the solar tie in.*



1. Turn off pool filter and set filter to backwash.
2. Locate the pipe that runs from the filter into the gas heater. Cut out enough of this pipe to install your solar equipment.

If there is no heater, this pipe will run directly into the ground, to the pool. In this case there may be a chlorinator device on the pipe. Make your tie-in Before the device. (You may need to relocate the device if it is too close to the filter.)

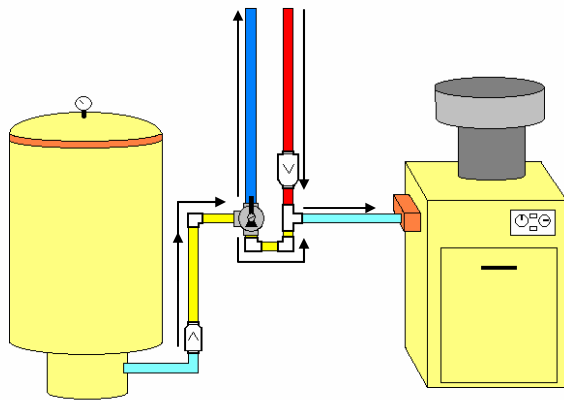
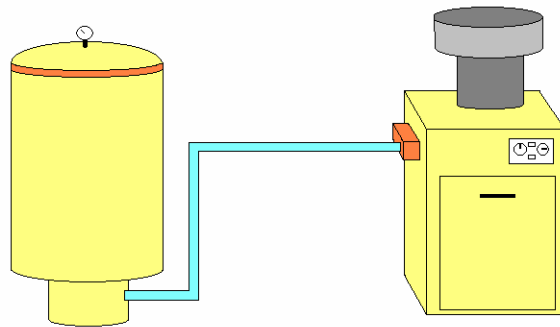

3. Install the check valve directly after the filter.
4. Install the solar valve after the check valve. (Connecting it like the diagram will make it easiest for installing an automatic controller.)
5. One port of the solar valve (shown in blue) will go to the solar collectors.
6. The other port will be plumbed to the return tee.
7. The other two ports of the return tee will connect to the solar collector return (shown in red) and the heater inlet (or pool return).
8. A check valve should be installed on the return line. This is not required for the operation of the system. It serves to isolate the system from getting any water when bypassed.

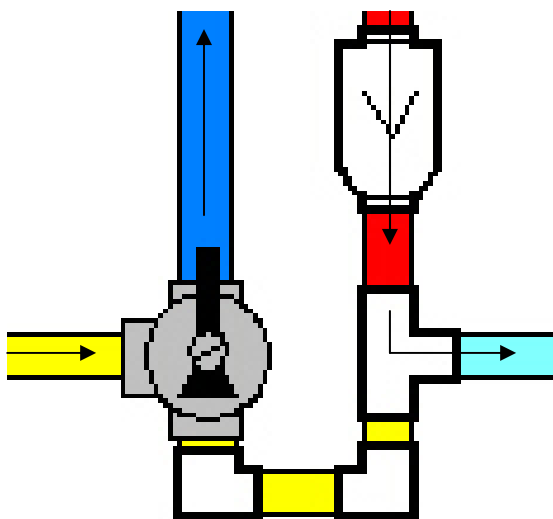

Valve position and flow with solar on

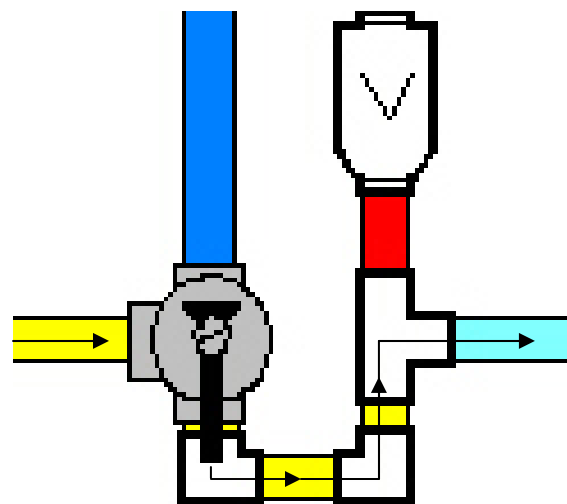

Valve position and flow with solar bypassed.

It's common for the pool equipment to be located right next to the house, allowing for the pipes to be run directly up the wall from the pool equipment. The weight of the pipes full of water can create a great amount of stress on the equipment if not properly strapped to the wall. Glue a coupler on the pipe shortly after the pipes turn up the side of the house and install 2in. wall clamps directly under them.

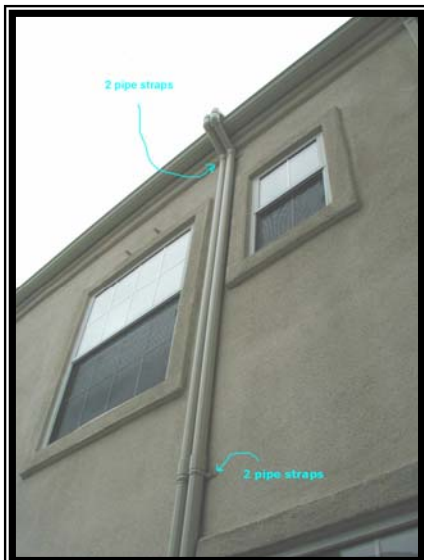

Very important! When wrapping pipes around an eve, always strap the pipes at the very top, just under the eaves.

Important To Read:

Included in our installation kit is the **Pentair solar valve**. Used to control water flow to the solar collectors, it has a drain down feature which allows water in the collectors to automatically drain back into the pool at night, when used with the **Pentair SolarTouch solar control system**.

FEATURES:

- Three 2" / 2.5" ports
- High flow rate
- Drain down check valve built into the diverter
- Positive sealing ports
- Easy turn handle
- CPVC valve body
- Maintenance free diverter
- Compatible with **Pentair, Jandy and Hayward** control actuators.

The installation kit and solar valve are sold separate and are not included as components of the NSF/ANSI Standard 50 Certified solar collector. An NSF/ANSI Standard 50 Certified valve should be used in applications requiring Certification.



Manual control application:

Without an auto control unit to turn the solar off every night, to prevent possible freeze damage, it is recommended that the Stop Pin on the valve handle be moved over one slot to allow the system to drain when the pump shuts off.

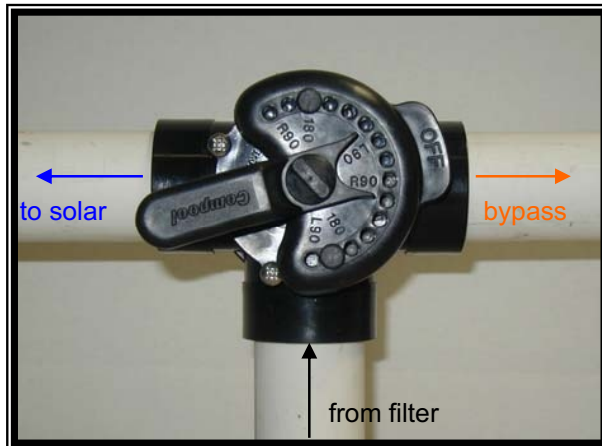

What separates the **Pentair solar valve** from any other three way valve is the drain down check valve. It's purpose is to allow the system to drain back into the pool when the solar is bypassed and the pump is off. In addition it creates a positive seal, isolating the system when the solar is off (When installed with a return line check valve).

When using other three way valves a 1/4" hole needs to be drilled into the diverter to allow system drainage. In addition a shut off valve needs to be installed on the solar feed line for system isolation.



Drainage and Drain Lines:

Essential to the longevity of any solar system is its ability to be drained of all water when the system is not in use. This usually can be achieved by simply keeping the supply pipe below the level of the system. When this cannot be done, a drain line needs to be installed or the system must be manually drained during winter months to prevent freeze damage and during the summer months when the pool is sufficiently warm without the solar to prevent overheating.

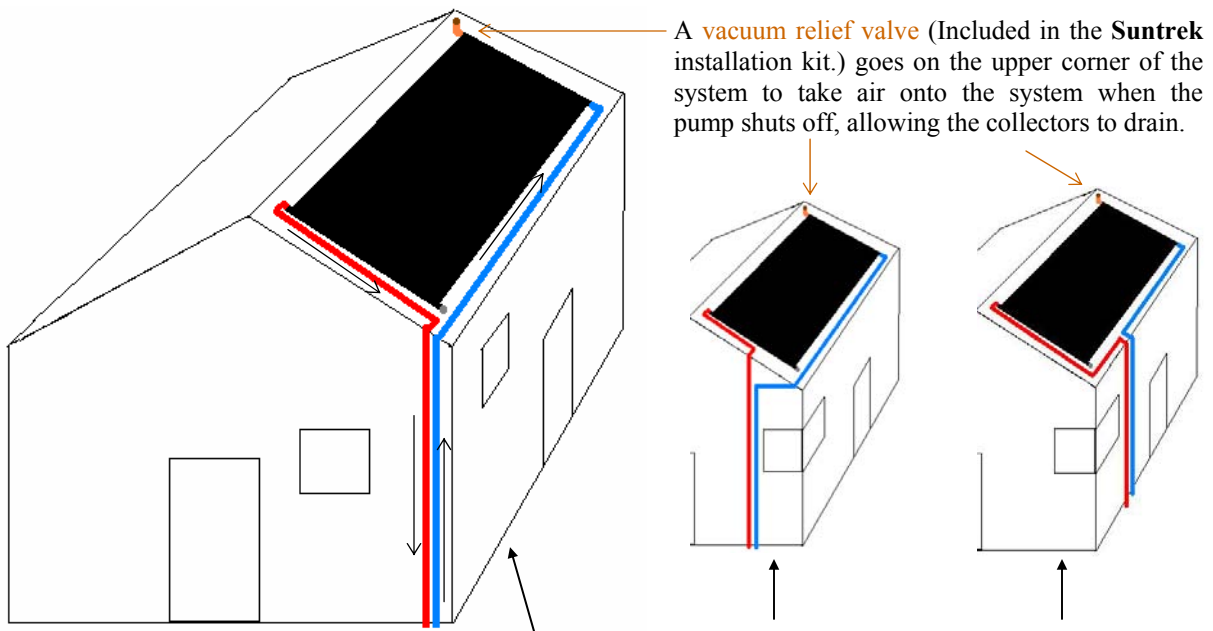

A **vacuum relief valve** (Included in the **Suntrek** installation kit.) goes on the upper corner of the system to take air onto the system when the pump shuts off, allowing the collectors to drain.

This diagram shows the typical plumbing scenario with the **solar supply** and **solar return** pipes coming up to the lowest part of the system for automatic drainage.

These diagrams show other common options when there are obstacles at the low corner of the house.

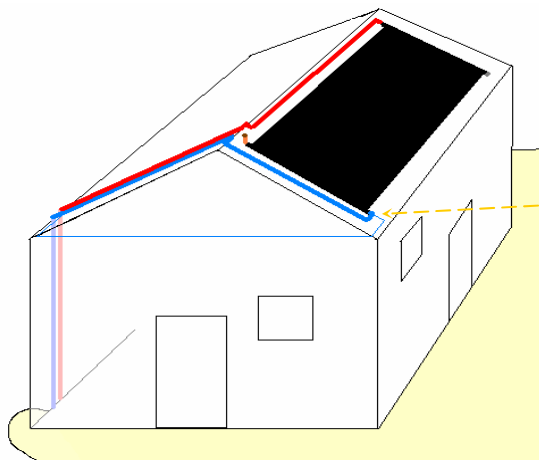

When there are no alternatives to going up and over the roof, a drain line made of 1/2" PVC pipe can be ran from the low point of the system around the house and tie back into the feed pipe or you can purchase a **suntrek** drain line kit.

Even a light frost can damage a solar system. Any water in the collectors will crystallize and expand, causing damage to the system and shortening the lifetime of the collectors. Included in the **Suntrek installation kit is a 3/4" hose bib for manual drain down of the system as a last resort.*

Split System Plumbing:

When installing multiple banks of collectors, special attention needs to be given to the plumbing design to ensure proper flow and drainage of all collectors.

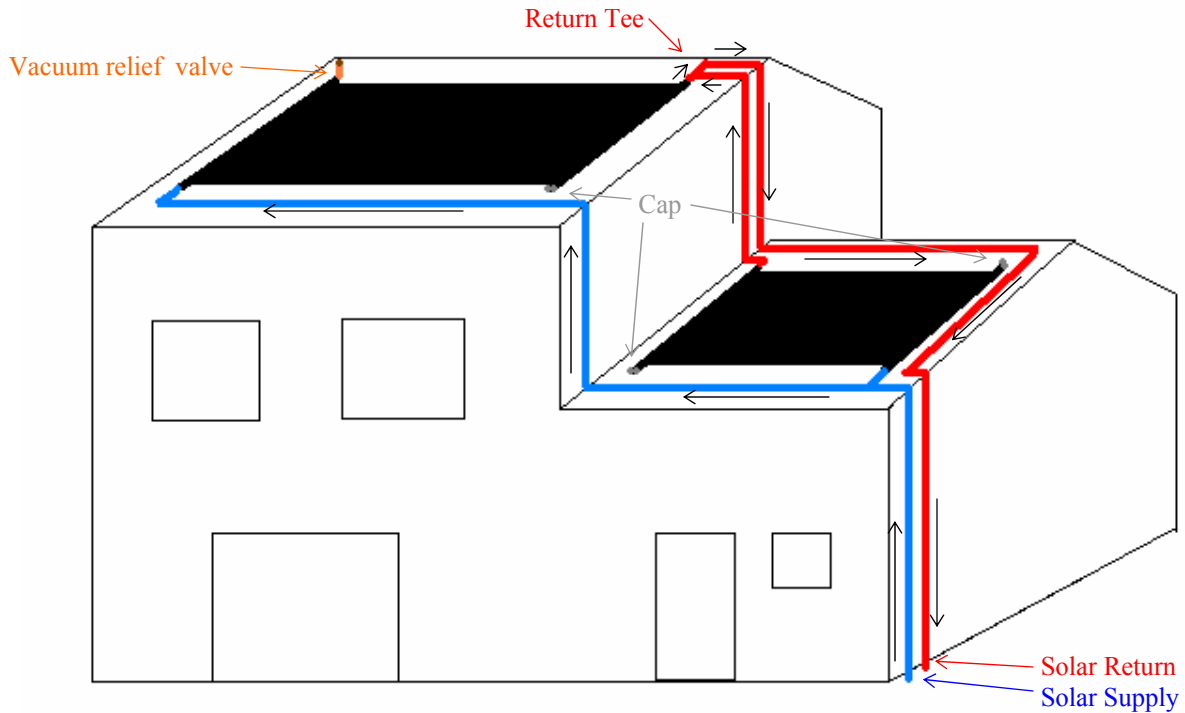

1. To allow for complete drainage, the **solar supply** pipe must be kept below the level of the collectors,
2. To ensure proper flow through all collectors, the **solar return** pipe must come off the opposite upper corner of the solar supply connection and be run to the highest point of the system before returning to the pool. (As illustrated above.)

*Another common split system is placing the collectors on opposite sides of a roof. (i.e. east and west.) This way usually requires a **drain line** to be run. (See previous page for explanation of drain lines.)*

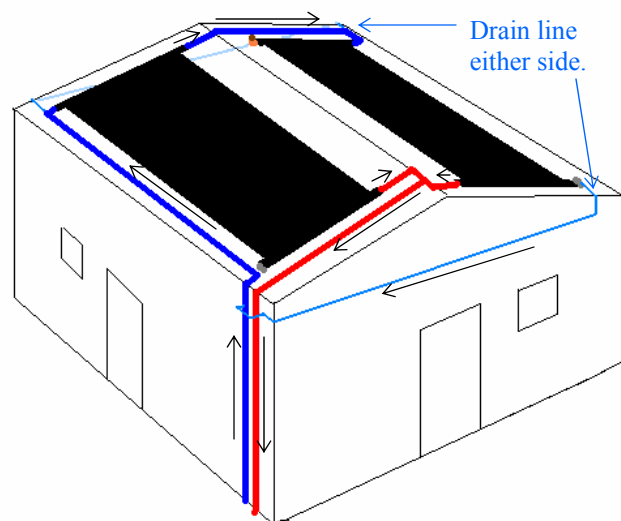

Automatic Controls:

A great addition to your **Suntrek** system is the **Pentair SolarTouch** automatic control system. It will increase the efficiency of your system by 15 to 20 percent by automatically bypassing the collectors when the sun is not directly shining on them. Water passing through the collectors at night, on a cool or rainy day, or even just a dark cloud passing overhead can cool the pool quickly through the collectors.

Included in the automatic control kit:

- 1- **SolarTouch** controller.
- 1- **Pentair** 3-way solar valve.
- 1- **Pentair** valve actuator.
- 1- Pool temp. sensor.
- 1- Solar temp. sensor.
- 1- Installation and operation guide.



Most automated pool systems come with solar control options and only require an additional valve actuator and solar sensor. Check your indoor controller or owners manual.



Pentair solar valve and actuator.

The automatic controller is sold separate and is not included as a component of the NSF/ANSI Standard 50 Certified solar collector

Make Safety a Priority:

Take Every precaution when installing your solar system. The following tips can help avoid injury.

1. Prevent ladder injuries.

Ladders should be of high quality and commercial grade and meet American national standards Institute standards. Check ladder before use. Defective ladders should be repaired or destroyed. Keep ladders away from power line. Place ladder on secure, even footing and secure it (tie-off) so that it will not shift while in use. Don't lean it against a movable object. Set ladder on an angle about 75 degrees to the ground. The steps of the ladder will be level when it is set up properly. Allow only one person on a ladder at a time. Face the ladder, grasping side rails or rungs with both hands. Extend the ladder three (3) feet above the roof line or landing. Where there is a danger of a person or vehicle bumping into a ladder, have a helper stand guard. Never step on a ladder rung that is above the roofline.

2. Wear good shoes that have a thick rubber sole.

3. Work with an assistant, never alone.

4. Do not work on a slippery roof. North sides are often mossy and extremely dangerous in morning dew conditions.

5. When working close to the edge or on a steep roof use a rope and harness to prevent falling from the roof.

6. Never walk backwards on a roof.

7. When possible, avoid working close to the edge of the roof.

8. Stack all materials and tools on the roof so they can't fall (behind plumbing vents or chimney).

9. Make sure there are no children playing near by and alert adults of possible dangers from above in case something were to fall from the roof.

10. When working with electricity, consult an electrician and make sure the power is turned off at the main breaker.

11. Never step on a power cord on a pitched roof. The cord will roll under your feet causing you to slip and possibly fall. Cordless tools are beneficial.

12. If you have any concerns with regards to the conditions of your tools, roof, electrical systems, pool system or any other aspect of the job, do not hesitate to contact a local professional or **Suntrek Industries** for assistance.

General Operating and Maintenance:

- If you have automatic controls, check that the power light is on and the thermostat is set in a "high" position. (you will need to find your ideal setting after the pool warms up.)
- Set your filter-pump time clock to turn on at the time that the sun directly hits the collectors in the morning (10:00 AM), and to turn off when the sun stops hitting the collectors (5:00 PM). Make day light saving adjustments accordingly.
- Your automatic controller will come with an owners manual for operation settings.

If the solar collectors are operated when the sun is not shining directly on them (at night or a rainy day), it will cool off the pool. If you have automatic controls, a solar sensor will keep this from happening.

- Turn solar system OFF before back washing the filter.(Do not turn solar back on until filter system has run for at least 20 minutes after back washing has been completed.)
- Turn solar system off while manually vacuuming pool.
- Do not walk on collector unit when possible.
- For swimming during long-night/cooler weather months, it is recommended that a pool blanket be floated on the surface of the pool to help prevent overnight heat loss.
- In areas that are subject to freezing conditions, the solar system MUST be shut off and drained during freezing periods to protect all components parts of the solar system. See "To freeze-protect system".
- Never let water remain stagnant in the collectors (be certain system is gravity-drained when off).
- In general, your Suntlet system will require little maintenance. However, to obtain the best possible performance, it is recommended that the collectors be kept free of dust and debris by simply turning a hose on them occasionally. It is advised that the system be inspected once a year and that the attachments between the collectors and the roof be examined on a regular basis to avoid damage from severe winds. Depending on the area, the recommended winterizing procedures may have to be performed.

Winterizing (in areas subject to freezing):

- Position automatic control switch to "OFF" (if automatic control system), OR turn solar valve to by-pass position (if manual system).
- Wait 10-15 minutes to be sure the system has drained completely.
- Open hose bib on roof to drain any remaining water from collectors. You can hook up an air compressor to the hose bib to blow collectors empty if there is any doubt that they are not completely drained.
- Leave system like this until after freeze conditions are over.

*Commercial Pools Drain Down Procedure:

Commercial pools that currently run filtration 24/7 must set a drain down period for the solar energy system. Set the time clock to turn all the pool filtration off for a period of ½ hour every day. The recommended time for this to occur is between 5pm-7pm. This will allow the solar system to drain every day when there is no longer any pressure in the system due to the filtration cycle. This will prevent the solar system from freezing in the winter and from long term stagnation year round. When the solar system starts up the following day, air bubbles will be seen entering the pool until the solar system has flushed all the air from the system.

Troubleshooting:

If the pool is not getting warm enough in sunny conditions:

- The filter may be dirty or clogged-check flow strength at pool outlets.
- The time clock may not be set for best sunshine times of the day.
- The thermostat may be set too low (if automatic system).
- Valve may be turned off. Check water routing.
- Pump may be weak and not be pumping a sufficient volume of water.
- Off-season months may require floating cover on pool to prevent night-time heat loss.
- Additional collectors may be necessary.

In general, it takes three days of consistent sunny weather in order for the pool to reach up to seasonal solar heated temperature.

Constant bubble in the pool when the solar on:

Every time the solar system turns on, the pump purges all the air from the system producing a large amount of bubbles in the pool, which should completely subside within two minutes. However, if you see a constant stream of bubbles throughout the day, this indicates a problem not necessarily related to the solar.

Insufficient flow through the solar collectors will draw air into the system through the vacuum breaker, as the water falls from the collectors quicker than the water is being pumped to the roof.

- Check the filter pressure with the solar off then check the pressure with the solar on. It is common for the filter pressure to raise 8-10 pounds when pumping water to the collectors.
- If the pressure is high (30 pounds or more) and does not increase with the solar on, this indicates the filter needs cleaning.
- If the filter pressure is abnormally low (10 pounds or less) and does not rise when the solar is activated, check the pool skimmer and pump basket for debris. If there is not restrictions your pump may be too weak and may need to be replaced.
- If the filter pressure is normal with the solar off and increases 15 pounds or more with the solar activated, this indicates that the solar collectors may be clogged with debris due to a break in a filter grid. If this is the case, first have your filter dismantled and repaired then contact your installer or **Suntrek Industries** for servicing a clogged system.

Water discoloration

Depending on your pool chemistry or lack of chlorine, it is possible to see the water discolor. Do not be alarmed. During the curing process of the solar collectors, a salt is sometimes discharged into the pool. If this condition exists, please make sure you have proper levels of conditioner and chlorine in your pool and the discoloration will disappear.

Commercial Pool Instruction Manual Addendum to support CSI Program in California

In order to comply and remain current with the new CSI commercial pool rebate program in California, this new section to our manual has been developed and will be updated as we learn more about program changes.

S-Shaped Tile Vertical Installations:

Vertical S shape tile roof installations will require a stringer (support member) to be attached to the ridge of the tile to provide a lateral support for the Suntrek collectors. A strapping system will hold the collectors down every 4 ft. See diagram below:

SUPPORT SYSTEM MOUNTED DIRECTLY TO AN "S" TILE ROOF TO PREVENT SAGGING WHEN COLLECTORS ARE RAN VERTICALLY

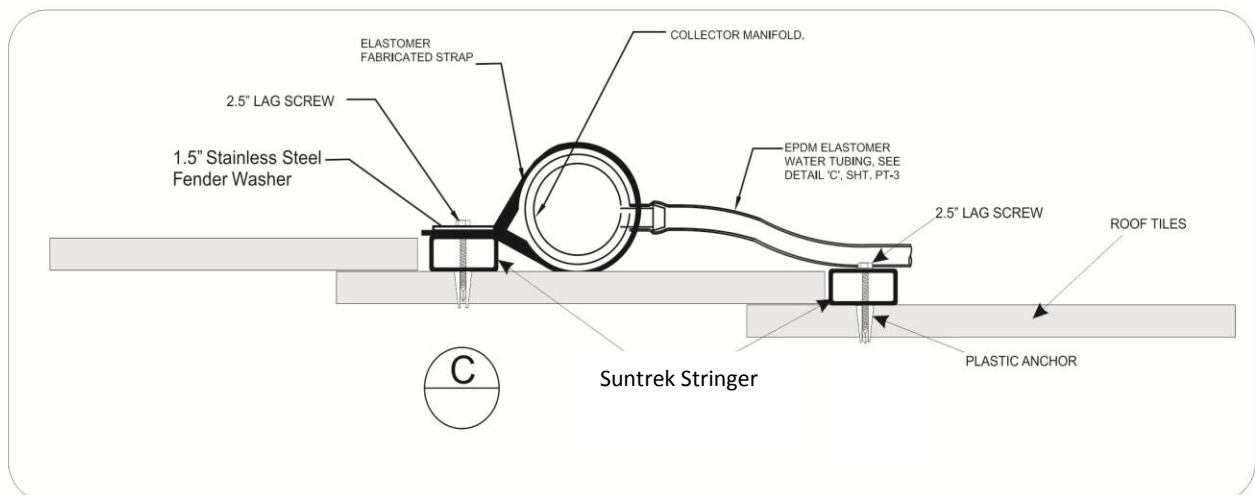
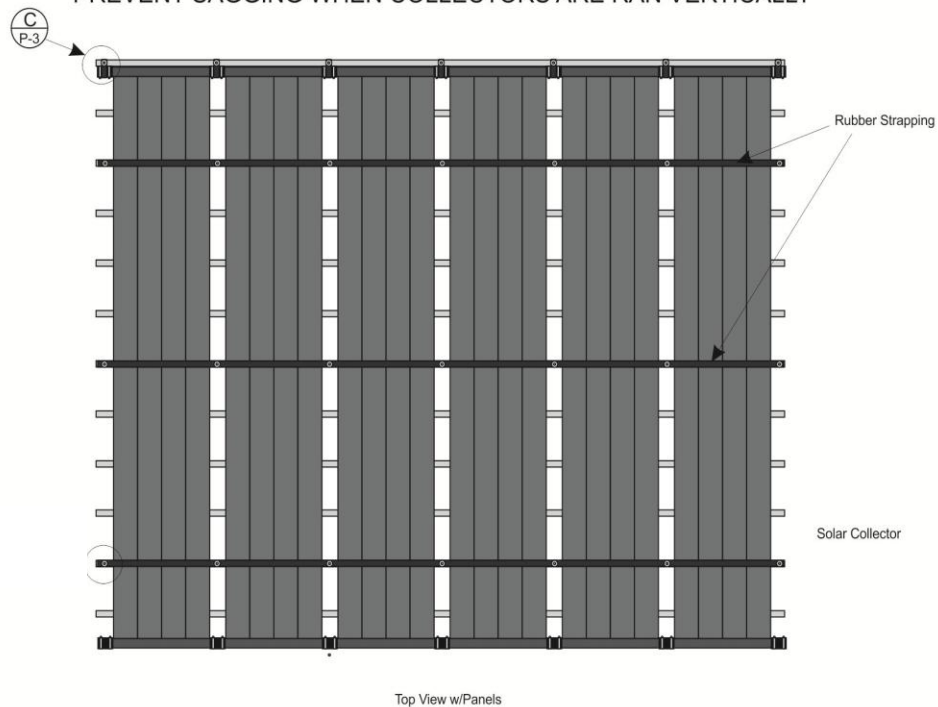

Suntrek has engineered a solution that can eliminate most, if not all, penetrations with a flat roof. See diagram below:

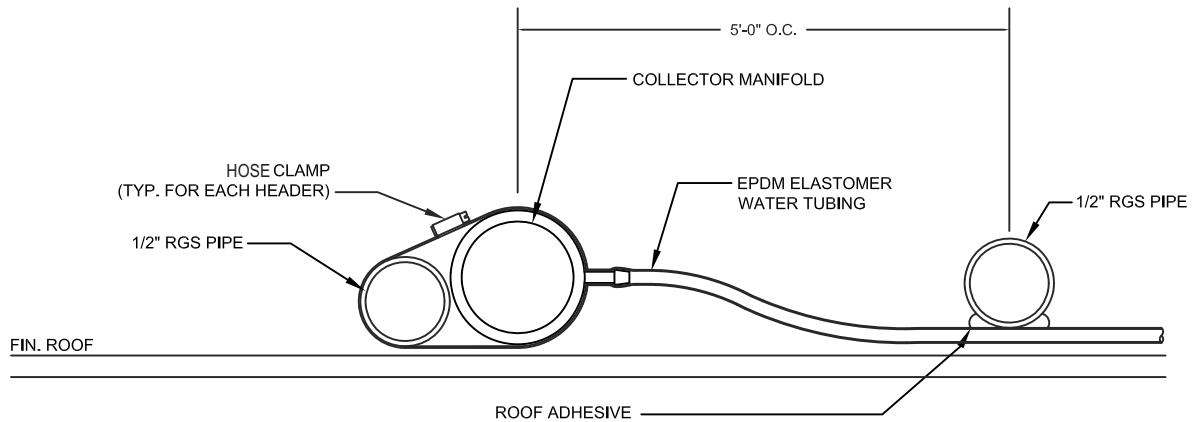

B SOLAR COLLECTOR MOUNTING DETAIL
SCALE: 1/2"=1'-0"

Winterization for Seasonal solar systems:

Seasonal Commercial Pool Solar systems can be installed vertical or horizontal and must have necessary drain mechanisms to allow for winterization. A hose bib will be installed so the system can be drained. Isolation valves will be installed at the pool equipment area so the solar system can be isolated and no water will go to the collectors. Suntrek will provide the customer with the drain down procedure for winterization to protect the system from freeze damage. The customer can also contract with Suntrek to provide this annual service. See drain pipe with hose bib and isolation valve diagram below:

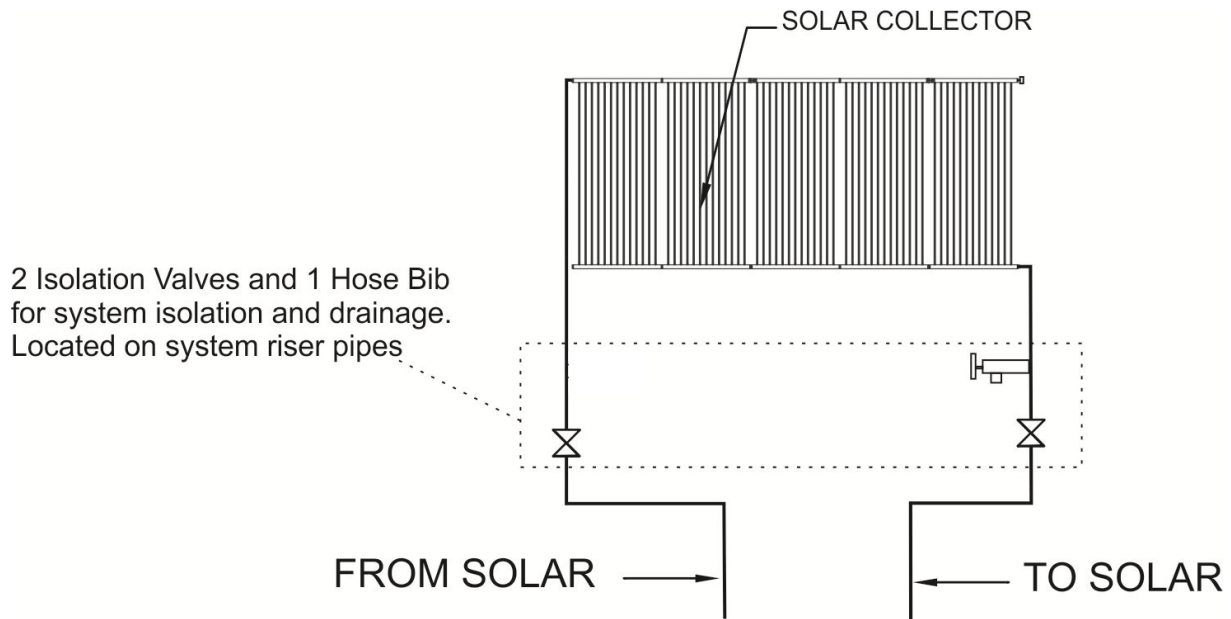

Winterization Maintenance Plan:

1. Turn pool equipment off.
2. Go up on the roof and inspect entire solar system attachments. Open all hose bibs. In some cases, the hose bibs may be run to ground level. Open to drain water from system.
3. Turn solar pool control system to off position. Inspect solar booster pump.
4. Close isolation valves on solar feed and returns.
5. Hook up a blower on the roof by disconnecting the feed line, end cap, and the return line to blow residual water from system. Reconnect all hose and clamps to the feed and return lines and close all hose bibs so that Spring start up is ready.
6. Spring start up should include opening the isolation valves.
7. Turn solar control system to automatic setting
8. Test the system for operation and leaks.

Year Round Solar Pool Systems:

Year round solar pool heating systems must be installed so the system can drain back by gravity and syphoning. A minimum of 1/4 inch per foot is required to achieve this objective. Most “flat” roofs have this minimum pitch. Install your Suntlet collectors so the feed is at the low point and your return at the high point of the roof slope. Make sure there is a time clock setting for the pool filtration so you can set aside a short down time period at sunset hours to allow the solar pool system to drain back to the pool each day. In the morning, you will see large bubbles coming to the pool which is air being purged from the collectors. The bubbles will then slowly go away as the solar collector begin to fill with water and heat your pool.

Suntlet collectors are very durable, flexible, and versatile. When there are slight sags in the system or roof, this will have no adverse effect on system drainage due to syphoning. When the water drops from the roof, gravity will pull most of the water from the system leaving ample space in the event there is residual water remaining so that this water can either expand in a freeze without structurally damaging the system or during warm weather, this water will remain or escape through evaporation by way of the VR valve.

Flat Roof Installations:

In order to increase performance and improve on system drain back, a racking system can be installed. See diagram below:

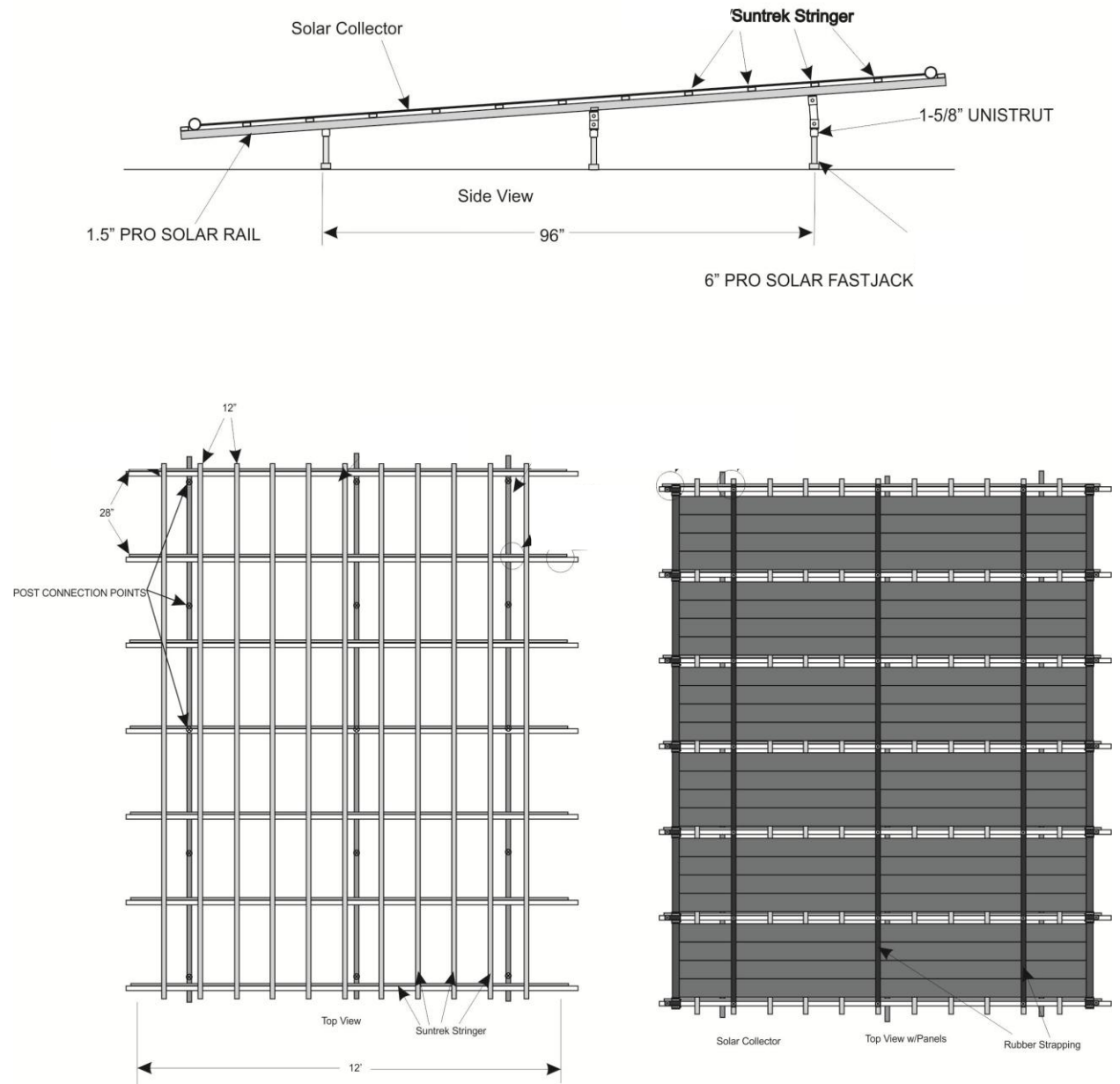

Flat roof drain lines:

There will be circumstances where drain back is impaired by slope issues and parapet walls. Install drain lines that will allow the water in the solar collectors to have a bridge between the lowest point of the collector array and tie into the feed or return lines at a point where gravity and syphoning will allow for system drain back. See page 41 of the Suntek Installation manual.

Solar Booster Pump:

All commercial systems require a booster pump. Suntek systems should have a minimum flow rate of 1 GPM for every 10 SF of solar collector area and a maximum flow rate of 2 GPM for every 10 SF of collector area. Size your pumping system accordingly.

Monitoring Systems:

For systems above 470 SF, a monitoring system is required. Due to the expense and inaccuracy of the metering systems, CSI is requiring that we input the flow from a flow meter into the monitoring system manually. The monitor will have two temperature sensors for inlet and outlet delta-T along with another sensor that will determine when the booster pump is on or off. With this input data, the monitor will display BTU's produced.

North Facing Roofs:

The CSI program will allow slightly pitched north facing roofs for collector installations.

WARNING

MAXIMUM FLOW RATE: The solar system flow rate should not exceed 2 gallons per minute for every 10 square feet of collector area. Excessive flow rates can cause damage to the solar system due to increased pressure over time.

MINIMUM FLOW RATE: The solar system flow rate should not be less than 1 gallon per minute for every 10 square feet of collector area. A low flow rate will cause the solar system to not perform efficiently.

WARNING: THE SOLAR SYSTEM SHALL BE INSTALLED IN FULL COMPLIANCE WITH SUNTREK'S MANUFACTURER'S RECOMMENDATIONS AS WELL AS THE LOCAL REGULATORY AND BUILDING CODE REQUIREMENTS FOR GAS SUPPLY, SOLAR, PLUMBING, AND ELECTRICAL, CODES AND CONDITIONS. CORROSIVE CHEMICALS SHOULD BE STORED AWAY FROM ALL SOLAR COMPONENTS TO MINIMIZE POTENTIAL DIRECT CONTACT TO THE EXTERIOR OF ALL SYSTEM PARTS.

WARNING: THE SOLAR SYSTEM SHALL NOT BE INSTALLED IMMEDIATELY AFTER THE INJECTION POINT FOR LOW PH OR ACIDIC CHEMICALS TO MINIMIZE POTENTIAL CORROSIVE DAMAGE TO THE INSIDE OF THE SOLAR HEATING COLLECTOR TUBING. ALL SALT CHLORINATING SYSTEMS ALSO APPLY TO THIS WARNING. AUTOMATIC CHLORINATORS AND SALT CHLORINATING SYSTEMS ARE TO BE INSTALLED DOWN STREAM FROM THE SOLAR SYSTEM RETURN LINE.

WARNING: PROPER MAINTENANCE AND USE OF ALL POOL CHEMICALS IS CRITICAL FOR MAINTAINING HEALTHY AND SAFE POOL CHEMISTRY FOR SWIMMING POOL USE AND ALL SOLAR AND POOL EQUIPMENT. CONSULT YOUR POOL SERVICE PROFESSIONAL AND BE AWARE THAT THE FOLLOWING RANGES ARE CONSIDERED SAFE (PER MILLION PARTS). PH 7.5-7.8; ALKALINITY 60-120; CALCIUM HARDNESS 220-350; CYANURIC ACID 30-50.

WARNING: WHEN A SOLAR SYSTEM FIRST STARTS UP OR HAS STAGNATED AND THEN STARTS UP AGAIN, THERE IS POTENTIAL RISK FOR HIGH WATER TEMPERATURES TO RETURN TO THE OUTLETS OF YOUR POOL AND SPA. STAY CLEAR OF ALL OUTLETS TO AVOID BEING SCOLDED BY HOT WATER.



5 Holland #215
Irvine, CA. 92618
(949)-348-9276 Fax (949) 348-1626
(800) 292-7648
www.suntreksolar.com

For assistance in sizing or ordering, The **Suntrek FREE HELP LINE** is:

1-800-2-WARM-IT

(Pacific Time business hours)

For assistance outside the USA, please use our e-mail at **ceo@suntreksolar.com**